

---

# FPC-9108 Series

Robust Box PC with Intel® Comet Lake-S  
Xeon® Core™ i9/i7/i5/i3 Processor

## User's Manual

Version 1.0



---

This page is intentionally left blank.

---

---

## Revision History

Version	Release Time	Description
1.0	2022.04	Initial release

<b>Revision History .....</b>	<b>i</b>
<b>Contents .....</b>	<b>ii</b>
<b>Preface.....</b>	<b>v</b>
Copyright Notice.....	v
Declaration of Conformity.....	v
CE .....	v
FCC Class A.....	v
RoHS.....	vi
SVHC / REACH.....	vi
Important Safety Instructions .....	vii
Warning.....	viii
Replacing Lithium Battery .....	viii
Technical Support.....	viii
Warranty.....	ix
<b>Chapter 1 - Introduction.....</b>	<b>1</b>
1.1. The Computer .....	2
1.2. About this Manual.....	3
1.3. Specifications .....	4
1.4. Inside the Package.....	8
1.5.1. Optional Accessories .....	8
1.5.2. Optional Configuration (CTOS* Kit) .....	9
<b>Chapter 2 - System Overview .....</b>	<b>11</b>
2.1. Dimensions .....	12
2.2. Take A Tour.....	14
2.2.1. Rear View.....	14
2.2.2 FPC-9108-P6-G3 Front View .....	15
2.2.2 FPC-9108-L2U4-G3 Front View.....	16
2.3. Driver Installation Notes .....	17
<b>Chapter 3 - System Configuration .....</b>	<b>19</b>
3.1. Board Layout.....	20
3.2. Pinheaders and Connectors.....	26
3.2.1. Pinheaders .....	26
3.2.2. Connectors .....	27
<b>Chapter 4 - Installation and Maintenance.....</b>	<b>49</b>
4.1. Install Hardware .....	50
4.1.1. Open the Computer.....	50
4.1.2. Install CPU .....	53
4.1.3. Install/Uninstall Memory Modules .....	54
4.1.4. Install Wi-Fi Module.....	58
4.1.5. Install Internal SATA Storage Device .....	62

4.1.6. Install PCI and PCI Express Cards .....	64
4.1.7. Install graphic cards .....	65
4.2. Wire DC-in Power Source .....	70
4.2.1 Automation Mode .....	70
4.2.2 Vehicle Application Mode .....	71
<b>Chapter 5 - BIOS .....</b>	<b>73</b>
5.1. Main .....	76
5.2. Advanced .....	77
5.2.1. CPU Configuration .....	78
5.2.2. Trusted Computing .....	80
5.2.3. ACPI Settings .....	81
5.2.4. Super IO Configuration .....	82
5.2.5. Hardware Monitor .....	84
5.2.6. S5 RTC Wake Settings .....	85
5.2.7. AMI Graphic Outut protocol policy .....	86
5.2.8. PCI Sybssystem Settings .....	87
5.2.9. USB Configuration .....	88
5.2.10. CSM Configuration .....	90
5.2.11. NVMe Configuration .....	91
5.3. Chipset .....	92
5.4. Security .....	98
5.4.1. Security Boot .....	99
5.5. Boot .....	100
5.6. Save & Exit .....	102
<b>Appendices .....</b>	<b>103</b>
A: Digital I/O Setting .....	104
B: Watchdog Timer (WDT) Setting .....	107

---

This page is intentionally left blank.

## Copyright Notice

All Rights Reserved.

The information in this document is subject to change without prior notice in order to improve the reliability, design and function. It does not represent a commitment on the part of the manufacturer.

Under no circumstances will the manufacturer be liable for any direct, indirect, special, incidental, or consequential damages arising from the use or inability to use the product or documentation, even if advised of the possibility of such damages.

This document contains proprietary information protected by copyright. All rights are reserved. No part of this document may be reproduced by any mechanical, electronic, or other means in any form without prior written permission of the manufacturer.

## Declaration of Conformity

### CE

The CE symbol on the computer indicates that it is in compliance with the directives of the Union European (EU). A Certificate of Compliance is available by contacting Technical Support.

This product has passed the CE test for environmental specifications when shielded cables are used for external wiring. We recommend the use of shielded cables. This kind of cable is available from ARBOR. Please contact your local supplier for ordering information.

### Warning

This is a class A product. In a domestic environment this product may cause radio interference in which case the user may be required to take adequate measures.

### FCC Class A

This device complies with Part 15 of the FCC Rules. Operation is subject to the following two conditions:

- (1) This device may not cause harmful interference, and
- (2) This device must accept any interference received, including interference that may cause undesired operation.

## Preface

---

### NOTE:

This equipment has been tested and found to comply with the limits for a Class A digital device, pursuant to Part 15 of the FCC Rules. These limits are designed to provide reasonable protection against harmful interference when the equipment is operated in a commercial environment. This equipment generates, uses, and can radiate radio frequency energy and, if not installed and used in accordance with the instruction manual, may cause harmful interference to radio communications. Operation of this equipment in a residential area is likely to cause harmful interference in which case the user will be required to correct the interference at his own expense.

### RoHS

ARBOR Technology Corp. certifies that all components in its products are in compliance and conform to the European Union's Restriction of Use of Hazardous Substances in Electrical and Electronic Equipment (RoHS) Directive 2002/95/EC.

The above mentioned directive was published on 2/13/2003. The main purpose of the directive is to prohibit the use of lead, mercury, cadmium, hexavalent chromium, polybrominated biphenyls (PBB), and polybrominated diphenyl ethers (PBDE) in electrical and electronic products. Member states of the EU are to enforce by 7/1/2006.

ARBOR Technology Corp. hereby states that the listed products do not contain unintentional additions of lead, mercury, hex chrome, PBB or PBDB that exceed a maximum concentration value of 0.1% by weight or for cadmium exceed 0.01% by weight, per homogenous material. Homogenous material is defined as a substance or mixture of substances with uniform composition (such as solders, resins, plating, etc.). Lead-free solder is used for all terminations (Sn(96-96.5%), Ag(3.0-3.5%) and Cu(0.5%)).

### SVHC / REACH

To minimize the environmental impact and take more responsibility to the earth we live, Arbor hereby confirms all products comply with the restriction of SVHC (Substances of Very High Concern) in (EC) 1907/2006 (REACH --Registration, Evaluation, Authorization, and Restriction of Chemicals) regulated by the European Union.

All substances listed in SVHC < 0.1 % by weight (1000 ppm)



## **Important Safety Instructions**

Read these safety instructions carefully

1. Read all cautions and warnings on the equipment.
2. Place this equipment on a reliable surface when installing. Dropping it or letting it fall may cause damage
3. Make sure the correct voltage is connected to the equipment.
4. For pluggable equipment, the socket outlet should be near the equipment and should be easily accessible.
5. Keep this equipment away from humidity.
6. The openings on the enclosure are for air convection and protect the equipment from overheating. **DO NOT COVER THE OPENINGS.**
7. Position the power cord so that people cannot step on it. Do not place anything over the power cord.
8. Never pour any liquid into opening. This may cause fire or electrical shock.
9. Never open the equipment. For safety reasons, the equipment should be opened only by qualified service personnel.
10. If one of the following situations arises, get the equipment checked by service personnel:
  - a. The power cord or plug is damaged.
  - b. Liquid has penetrated into the equipment.
  - c. The equipment has been exposed to moisture.
  - d. The equipment does not work well, or you cannot get it to work according to the user's manual.
  - e. The equipment has been dropped or damaged.
  - f. The equipment has obvious signs of breakage.
11. Keep this User's Manual for later reference.

### **Warning**

The Box PC and its components contain very delicately Integrated Circuits (IC). To protect the Box PC and its components against damage caused by static electricity, you should always follow the precautions below when handling it:

1. Disconnect your Box PC from the power source when you want to work on the inside.
2. Use a grounded wrist strap when handling computer components.
3. Place components on a grounded antistatic pad or on the bag that came with the Box PC, whenever components are separated from the system.

### **Replacing Lithium Battery**

Incorrect replacement of the lithium battery may lead to a risk of explosion.

The lithium battery must be replaced with an identical battery or a battery type recommended by the manufacturer.

Do not throw lithium batteries into the trash can. It must be disposed of in accordance with local regulations concerning special waste.

### **Technical Support**

If you have any technical difficulties, please consult the user's manual first at:  
<http://www.arbor-technology.com>

Please do not hesitate to e-mail our customer service when you still cannot find out the answer.

E-mail: [info@arbor.com.tw](mailto:info@arbor.com.tw)

## **Warranty**

This product is warranted to be in good working order for a period of one year from the date of purchase. Should this product fail to be in good working order at any time during this period, we will, at our option, replace or repair it at no additional charge except as set forth in the following terms. This warranty does not apply to products damaged by misuse, modifications, accident or disaster.

Vendor assumes no liability for any damages, lost profits, lost savings or any other incidental or consequential damage resulting from the use, misuse of, or inability to use this product. Vendor will not be liable for any claim made by any other related party.

Vendors disclaim all other warranties, either expressed or implied, including but not limited to implied warranties of merchantability and fitness for a particular purpose, with respect to the hardware, the accompanying product's manual(s) and written materials, and any accompanying hardware. This limited warranty gives you specific legal rights.

Return authorization must be obtained from the vendor before returned merchandise will be accepted. Authorization can be obtained by calling or faxing the vendor and requesting a Return Merchandise Authorization (RMA) number. Returned goods should always be accompanied by a clear problem description.

---

This page is intentionally left blank.

---

# Chapter 1

## Introduction

### 1.1. The Computer

#### FPC-9108-P6-G3



- Intel 10th Gen (Comet Lake-S ) with W480E chipset
- Supports NVIDIA® RTX-30 series up to 350W GPU( up to 334.6mm length)
- Wide Range DC power input (24~36V)
- HDMI x 1 +VGA x1 ( 2 independent display )
- Power on/off delay control/ Configurable ignition power control
- TPM2.0 support
- 2 x outside accessible SATA SSD, supporting RAID 0,1
- 2 x USB3.2 supports up to 10Gbps data transfer rate
- Front-accessible I/O support
- PWM FAN control support
- 6 x 802.3af Gigabit PoE ports
- 1 x M.2 (NGFF) B-Key(2242/3052/2280) socket for storage or 5G / LTE
- 1 x M.2 (NGFF) E-Key(2230) socket for WiFi / BT

## FPC-9108-L2U4-G3



- Intel 10th Gen (Comet Lake-S ) with W480E chipset
- Supports NVIDIA® RTX-30 series up to 350W GPU( up to 334.6mm length)
- Wide Range DC power input (24~36V)
- HDMI x 1 +VGA x1 ( 2 independent display )
- Power on/off delay control/ Configurable ignition power control
- TPM2.0 support
- 2 x outside accessible SATA SSD, supporting RAID 0,1
- 2 x USB3.2 supports up to 10Gbps data transfer rate
- Front-accessible I/O support
- PWM FAN control support
- 1 x M.2 (NGFF) B-Key(2242/3052/2280) socket for storage or 5G / LTE
- 1 x M.2 (NGFF) E-Key(2230) socket for WiFi / BT

### 1.2. About this Manual

This manual is meant for the experienced users and integrators with hardware knowledge of personal computers. If you are not sure about the description herein, consult your vendor before further handling.

We recommend that you keep one copy of this manual for the quick reference for any necessary maintenance in the future. Thank you for choosing ARBOR products.

### 1.3. Specifications

#### FPC-9108-P6-G3

System	
<b>CPU</b>	10th generation Intel® Xeon®Core™i9/i7/i5/i3 processor in LGA1200 socket
<b>Memory</b>	2 x 260-pin DDR4 SO-DIMM sockets, supporting 2933 ( i9/i7 CPU)/2666(i5/i3CPU)/2400 MHz (Pentium/ Celeron CPU) SDRAM up to 64GB (ECC / Non-ECC)
<b>Chipset</b>	Intel® W480E
<b>Graphics</b>	Integrated Intel® HD Graphics
<b>ATA</b>	2 x Serial ATA ports with 600MB/s HDD transfer rate
<b>LAN Chipset</b>	1 x Intel® WGI225LM 2.5GigE LAN 1 x Intel® WGI219LM PCIe controllers w/ iAMT14.0 6 x Intel® WGI211AT PCIe controllers for PoE
<b>Watchdog Timer</b>	1~255 levels reset
I/O	
<b>Serial Port</b>	2 x RS-232/422/485 configurable (default RS-232)
<b>USB Port</b>	2 x USB 3.2 Gen2 (10Gbps) / 2.0 ports 2x USB 2.0
<b>LAN</b>	2 x RJ-45 ports for GbE/2.5GbE 6 x RJ-45 ports for PoE (Power budget 60W)
<b>Video Port</b>	1 x HDMI 1 x DB-15 female connector for Analog RGB
<b>Digital I/O Port</b>	1x DB25 connector for DIO ( 8 in /8 out ) port
<b>Audio</b>	Mic-in/Line-out
<b>Expansion Bus</b>	1 x mini-PCI Express Slot interconnected with SIM card sockets for optional WiFi/BT/3G/LTE/GPS (PClex1+USB2.0, Full Size) 1 x M.2 E key ( 2230) with PClex1+USB2.0, for Wireless 1 x M.2 B key ( 2242/3052/2280 ) w/ (PClex2+USB3.0+SATA ) interconnected with SIM for 5G / LTE expansion or for storage ( either one) 1 x PCIe x16 slot for 350W GPU card 3 x PCI slots



<b>Environmental</b>	
<b>Operating Temp.</b>	80W TDP CPU : -20 ~ 50°C (-4 ~ 122°F) 65W TDP CPU : -20 ~ 55°C (-4 ~ 131°F) 35W TDP CPU : -20 ~ 70°C (-4 ~ 158°F) w/ NVIDIA® RTX-3090 : -20 ~ 45°C (-4 ~ 112°F)
<b>Storage Temp.</b>	-40 ~ 85°C (-40 ~ 185°F)
<b>Operating Humidity</b>	10 ~ 95% @ 50°C (non-condensing)
<b>Vibration</b>	Comply with MIL-STD-810G, Method 514.6, Category 4 w/ SSD
<b>Shock</b>	Comply with MIL-STD-810G, Method 516.6, Table 516.6-II, 20G
<b>Qualification</b>	
<b>Certification</b>	CE, FCC Class A
<b>Power Requirement</b>	
<b>Main Power Input</b>	DC 12~36V input (w/ 2-pin DC input terminal block )
<b>Secondary Power Input</b>	DC 24-36V input ( w/ 4-pin DC input terminal block for graphic cards power support)
<b>Ignition Switch</b>	2-pin terminal block: IGN, GND
<b>Storage</b>	
<b>Type</b>	2 x 2.5" drive bays (outside accessible ) 1 x M.2 B key ( 2242/3052/2280 ) w/ (PClex2+USB3.0+SATA ) interconnected with SIM for 5G/ LTE expansion or storage ( either one)
<b>Mechanical</b>	
<b>Construction</b>	Metal
<b>Mounting</b>	Wall-mount
<b>Weight</b>	7.4 kg (16.31lb)
<b>Dimensions (W x D x H)</b>	181 x 380 x 250 mm
<b>OS Support</b>	
Windows 10 IOT Enterprise 2019; Linux ( Kernal 4.9 )	
<b>Ordering Information</b>	
<b>FPC-9108-P6-G3</b>	Ruggedized Edge AI Computing Platform supporting NVIDIA® RTX-3090 GPU Card, Intel® 10th Gen Xeon® Core™ Processor with 6 x GbE PoE ( Up to 80W TDP CPU)

## Introduction

---

### FPC-9108-L2U4-G3

System	
<b>CPU</b>	10th generation Intel® Xeon®Core™i9/i7/i5/i3 processor in LGA1200 socket
<b>Memory</b>	2 x 260-pin DDR4 SO-DIMM sockets, supporting 2933 ( i9/ i7 CPU)/2666(i5/i3CPU)/2400 MHz (Pentium/ Celeron CPU) SDRAM up to 64GB (ECC / Non-ECC)
<b>Chipset</b>	Intel® W480E
<b>Graphics</b>	Integrated Intel® HD Graphics
<b>ATA</b>	2 x Serial ATA ports with 600MB/s HDD transfer rate
<b>LAN Chipset</b>	1 x Intel® WGI225LM 2.5GigE LAN 1 x Intel® WGI219LM PCIe controller w/ iAMT14.0 2 x Intel® WG82583V PCIe controllers
<b>Watchdog Timer</b>	1~255 levels reset
I/O	
<b>Serial Port</b>	2 x RS-232/422/485 configurable (default RS-232) 2 x RS-232
<b>USB Port</b>	2 x USB 3.2 Gen2 (10Gbps) / 2.0 ports 4 x USB 3.2 Gen1 (5Gbps) / 2.0 ports 2x USB 2.0
<b>LAN</b>	3 x RJ-45 ports for GbE 1 x RJ-45 ports for 2.5GbE
<b>Video Port</b>	1 x HDMI 1 x DB-15 female connector for Analog RGB
<b>Digital I/O Port</b>	1 x DB25 connector for DIO ( 8 in /8 out ) port
<b>Audio</b>	Mic-in/Line-out
<b>Expansion Bus</b>	1 x mini-PCI Express Slot interconnected with SIM card sockets for optional WiFi/BT/3G/LTE/GPS (PCIex1+USB2.0, Full Size) 1 x M.2 E key ( 2230) with PCIex1+USB2.0, for Wireless 1 x M.2 B key ( 2242/3052/2280 ) w/ (PCIex2+USB3.0+SATA ) interconnected with SIM for 5G / LTE expansion or for storage ( either one) 1 x PCIe x16 slot for 350W GPU card 3 x PCI slots

<b>Environmental</b>	
<b>Operating Temp.</b>	80W TDP CPU : -20 ~ 50°C (-4 ~ 122°F) 65W TDP CPU : -20 ~ 55°C (-4 ~ 131°F) 35W TDP CPU : -20 ~ 70°C (-4 ~ 158°F) w/ NVIDIA® RTX-3090 : -20 ~ 45°C (-4 ~ 112°F)
<b>Storage Temp.</b>	-40 ~ 85°C (-40 ~ 185°F)
<b>Operating Humidity</b>	10 ~ 95% @ 50°C (non-condensing)
<b>Vibration</b>	Comply with MIL-STD-810G, Method 514.6, Category 4 w/ SSD
<b>Shock</b>	Comply with MIL-STD-810G, Method 516.6, Table 516.6-II, 20G
<b>Qualification</b>	
<b>Certification</b>	CE, FCC Class A
<b>Power Requirement</b>	
<b>Main Power Input</b>	DC 12~36V input (w/ 2-pin DC input terminal block )
<b>Secondary Power Input</b>	DC 24-36V input ( w/ 4-pin DC input terminal block for graphic cards power support)
<b>Ignition Switch</b>	2-pin terminal block: IGN, GND
<b>Storage</b>	
<b>Type</b>	2 x 2.5" drive bays (outside accessible ) 1 x M.2 B key ( 2242/3052/2280 ) w/ (PClex2+USB3.0+SATA ) interconnected with SIM for 5G/ LTE expansion or storage ( either one)
<b>Mechanical</b>	
<b>Construction</b>	Metal
<b>Mounting</b>	Wall-mount
<b>Weight</b>	7.4 kg (16.31lb)
<b>Dimensions (W x D x H)</b>	181 x 380 x 250 mm
<b>OS Support</b>	
Windows 10 IOT Enterprise. 2019 Linux ( Kernal 4.9 )	
<b>Ordering Information</b>	
<b>FPC-9108-L2U4-G3</b>	Ruggedized Edge AI Computing Platform supporting NVIDIA® RTX-3090 GPU Card, Intel® 10th Gen Xeon® Core™ Processor ( Up to 80W TDP CPU)

## 1.4. Inside the Package

Upon opening the package, carefully inspect the contents. If any of the items is missing or appears damaged, contact your local dealer or distributor. The package should contain the following items:



1 x FPC-9108 Series  
Robust System





1 x User's Manual

### 1.5.1. Optional Accessories

The following items are normally optional, but some vendors may include them as a standard package, or some vendors may not carry all the items.





---

WMK-7000	Wall-mount kit for FPC-7XXX Series	
PAC-180W6C-FSP	180W AC/DC 24V adapter kit (For System )	
PAC-280W6C-MW	280W AC/DC 24V adapter kit ( For GPU Box )	
PAC-480W6C-MW	480W AC/DC 24V DIN Rail adapter kit (For System + GPU Box)	

---

### 1.5.2. Optional Configuration (CTOS\* Kit)

Make the computer more tailored to your needs by selecting one or more components from the list below to be fabricated to the computer.

MK-4C-4G/8G/16G/32G	DDR4-2400 4GB/8GB/16GB/32G(DDR4-2933) SDRAM DIMM kit	
WIFI-IN2550	Intel AX200NGW M.2 Wi-Fi 6 module w/ 2 x 30cm internal wires	
ANT-H11	1 x 2dBi HSUPA antenna	
ANT-D11	1 x WiFi dual-band 2.4G/5G antenna	
Xeon® W-1250E	Intel® Xeon® W-1250E processor, L2/12M, 3.5G	
Core™ i9-10900E	Intel® 10th Gen. Core™ i9-10900E processor, L2/20M, 2.8G	
Core™ i9-10900TE	Intel® 10th Gen. Core™ i9-10900TE processor, L2/20M, 1.8G	
Core™ i7-10700E	Intel® 10th Gen. Core™ i7-10700E processor, L2/16M, 2.9G	
Core™ i7-10700TE	Intel® 10th Gen. Core™ i7-10700TE processor, L2/16M, 2.0G	
Core™ i5-10500E	Intel® 10th Gen. Core™ i5-10500E processor, L2/12M, 3.1G	
Core™ i5-10500TE	Intel® 10th Gen. Core™ i5-10500TE processor, L2/12M, 2.3G	
Core™ i3-10100E	Intel® 10th Gen. Core™ i3-10100E processor, L2/6M, 3.2G	
Core™ i3-10100TE	Intel® 10th Gen. Core™ i3-10100TE processor, L2/6M, 2.3G	

---

This page is intentionally left blank.

---

# Chapter 2

## System Overview

# System Overview

## 2.1. Dimensions

FPC-9108-P6-G3

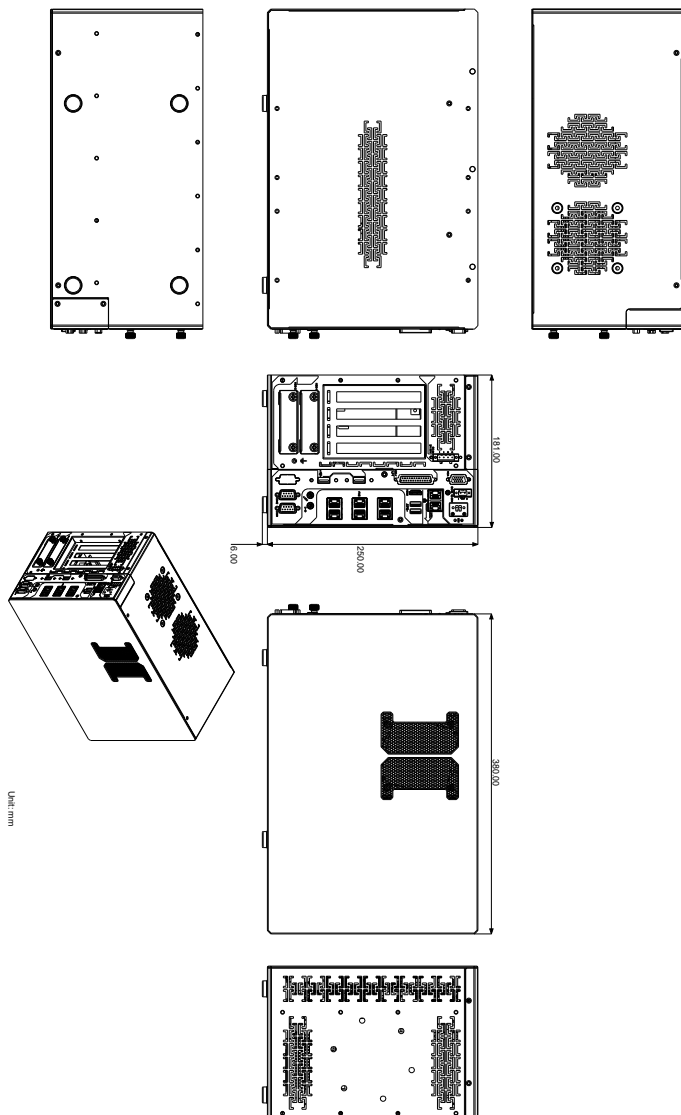



FPC-9108-L2U4-G3

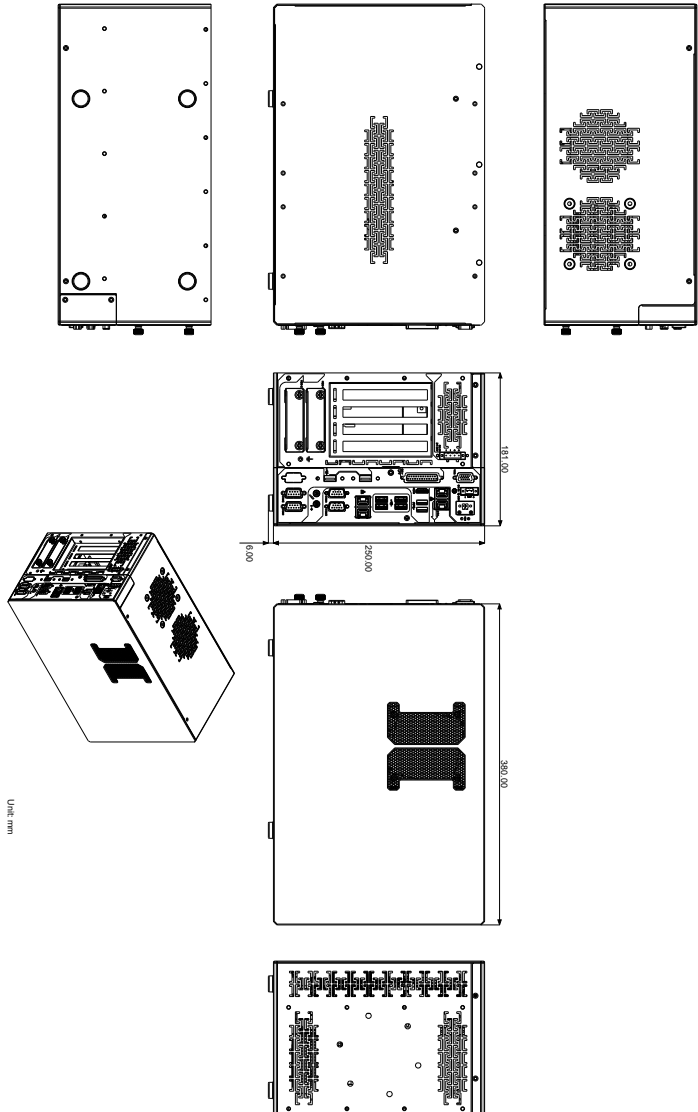

## 2.2. Take A Tour

### 2.2.1. Rear View

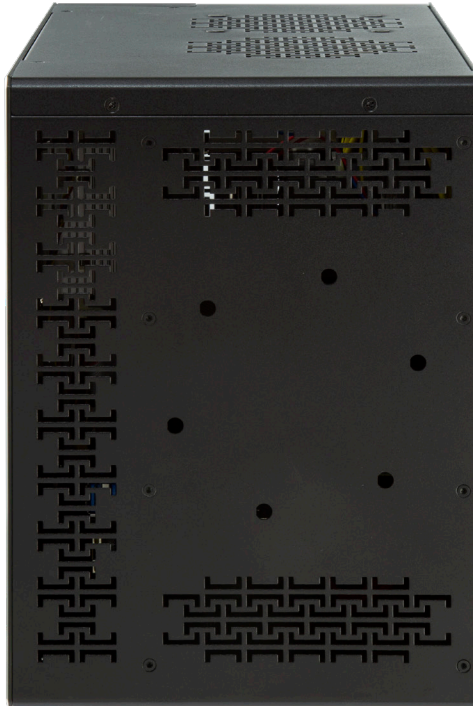

## 2.2.2 FPC-9108-P6-G3 Front View

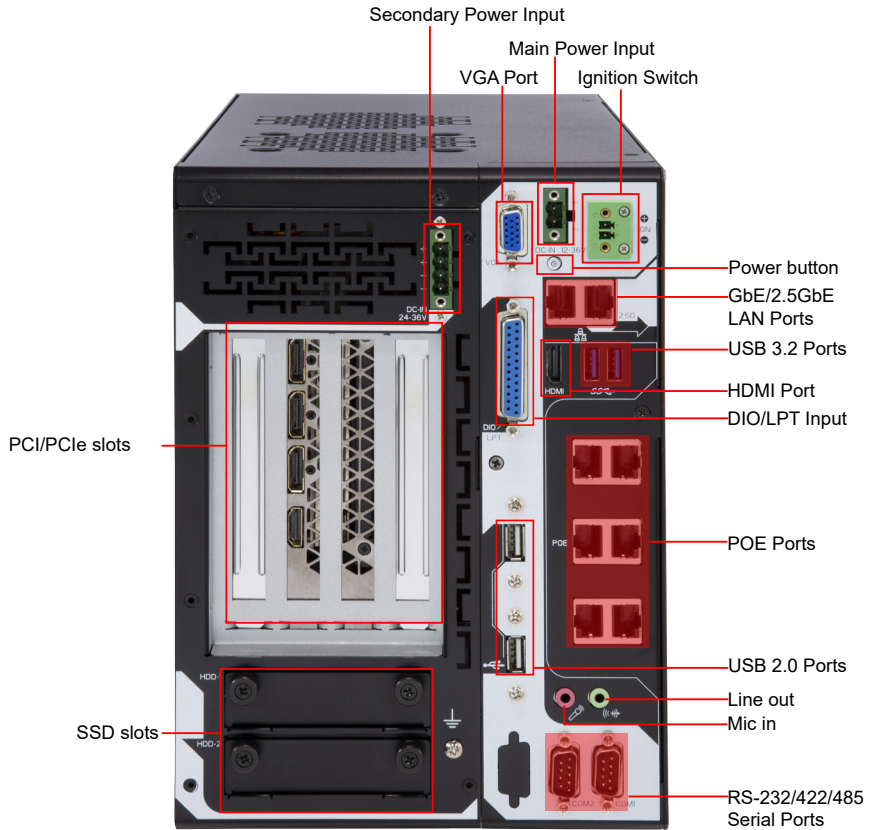

## 2.2.2 FPC-9108-L2U4-G3 Front View

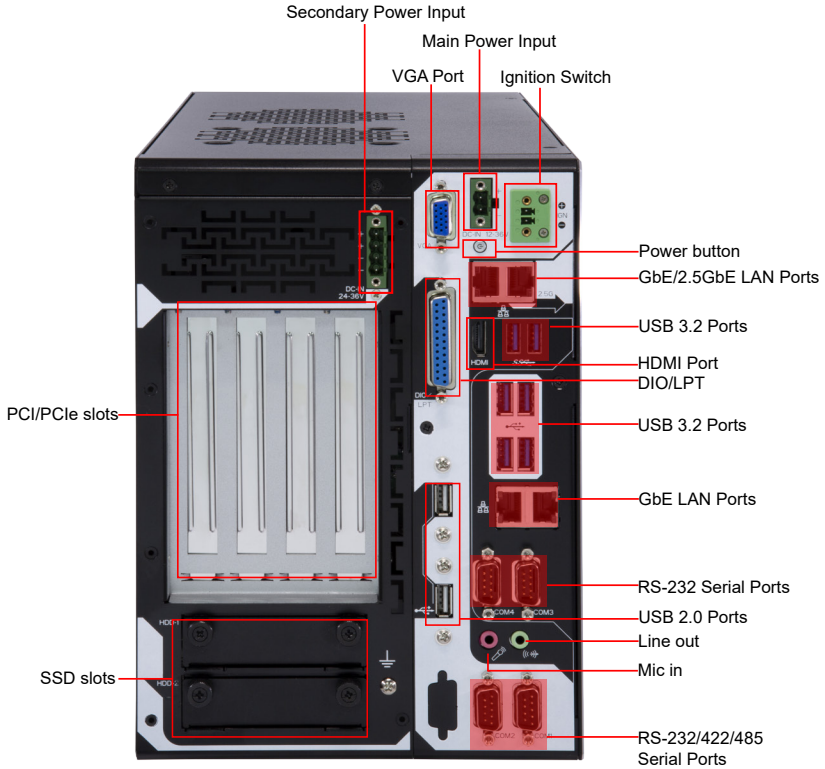

---

## 2.3. Driver Installation Notes

The CPU module supports Windows 10 64-bit and Linux. To install the drivers, please go to our website at [www.arbor-technology.com](http://www.arbor-technology.com) and download the driver pack from the product page. Then extract the downloaded file and follow the sequence below to install the drivers:

**Chipset** → **Graphic** → **Audio** → **Other drivers**

The driver path is listed as below:

### Windows 10

Driver	Path
Chipset	\\WIN10\Chipset\10.1.1.42\SetupChipset.exe
LAN	\\WIN10\Ethernet\PROWinx64.exe
VGA	\\WIN10\Graphics\Setup.exe
Audio	\\WIN10\AUDIO\0006-64bit_Win7_Win8_Win81_Win10_R279.exe
ME	\\WIN10\ME_11.6\SetupME.exe

---

This page is intentionally left blank.

---

# Chapter 3

## System Configuration

### 3.1. Board Layout

#### Board Top

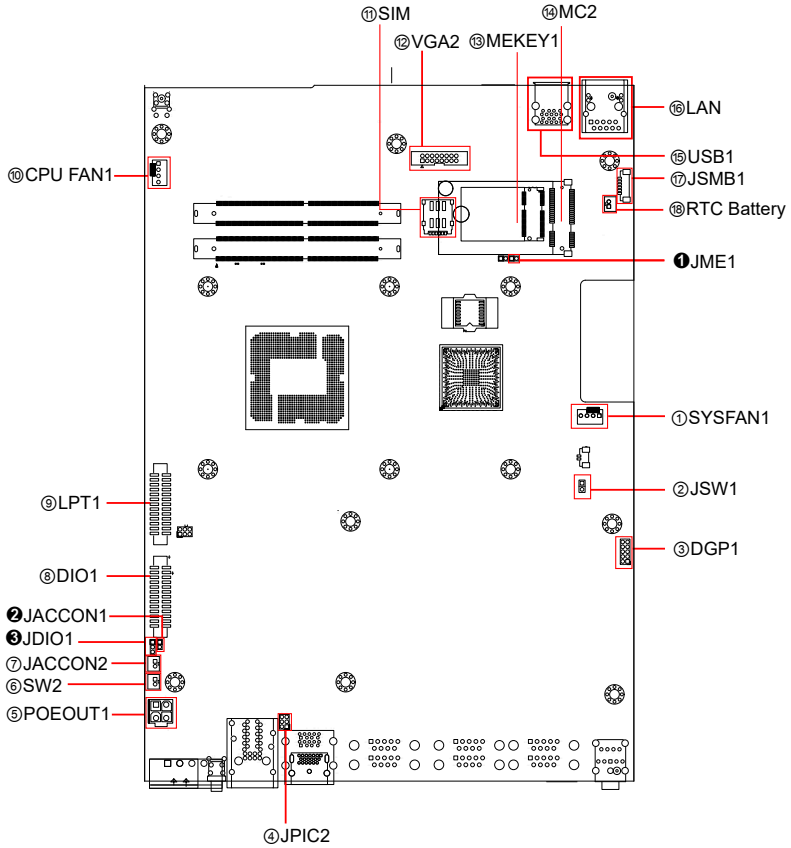



Board Bottom

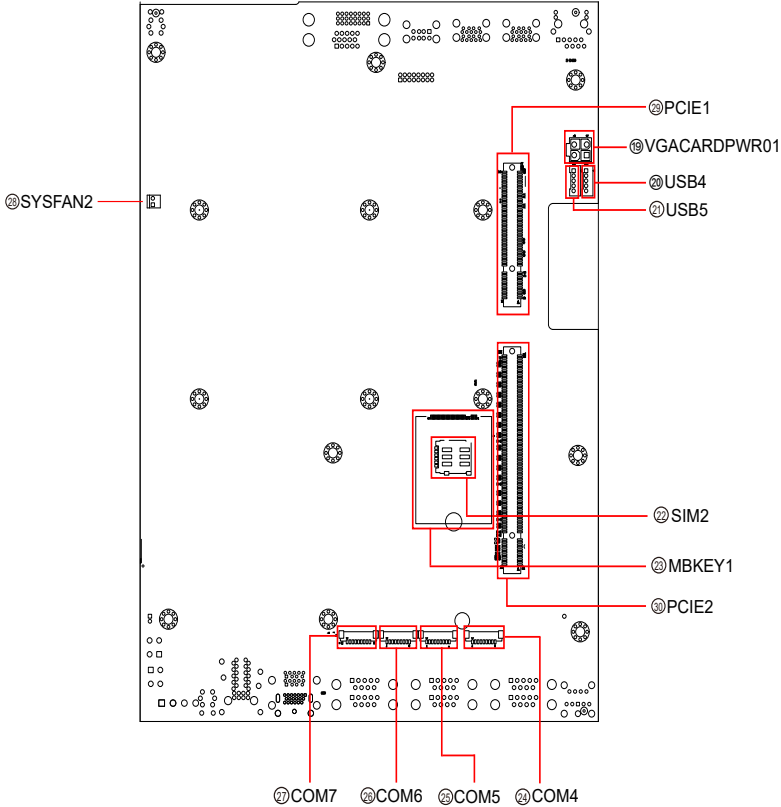

## Engine of the Computer

---

### Jumpers

Label	Description
① JME1	Clear CMOS selection
② JACCON1	ACC ON Mode selection
③ JDIO1	Ignition power mode

### Connectors

Label	Description
① SYSFAN1	Fan power connector
② JSW1	System reset pin header
③ DGP1	External 80 port pin header
④ JPIC2	Vcore IC debug pin header
⑤ POEOUT1	PoE power connector
⑥ SW2	System switch
⑦ JACCON2	Ignition Power connector
⑧ DIO1	Digital IO Connector
⑨ LPT1	On-board parallel port connector
⑩ CPUFAN1	Fan power connector
⑪ SIM	Nano SIM card socket
⑫ VGA2	Analog RGB
⑬ MEKEY1	M.2 E-Key socket
⑭ MC2	PCI Express Mini-card socket
⑮ USB1	USB Connector
⑯ LAN1	GbE RJ-45 Ethernet connector
⑰ JSMB1	SMbus wafer connector
⑱ RTC Battery	RTC Battery
⑲ VGACARDPWR1	Power output for VGA card
⑳ ㉑ USB4,5	USB wafer connector
㉒ SIM2	Nano SIM card socket
㉓ MBKEY1	M.2 B-Key socket

---

---

②④ ②⑤	COM4, COM5	RS232 connector
②⑥ ②⑦	COM6, COM7	RS232/RS422/RS485 connector
②⑧	SYSFAN2	Fan power connector
②⑨	PCIE1	PCI Expansion Slot
③⑩	PCIE2	PCI Expansion Slot

---

## Riser board-SCDB-649Y

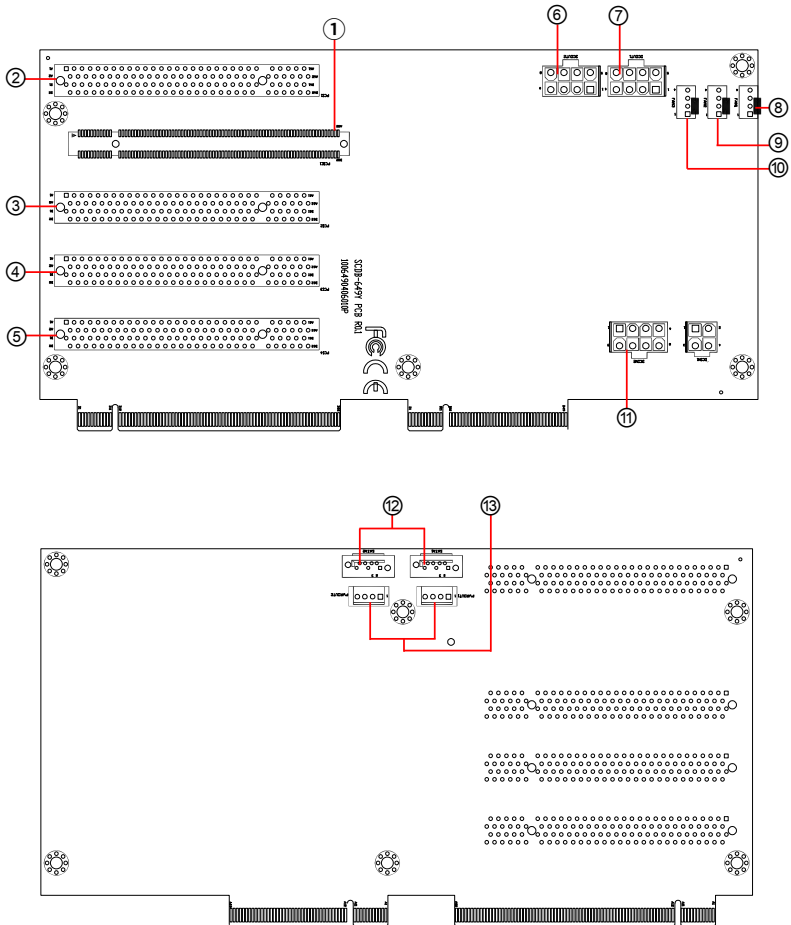

### Connectors



<b>Label</b>	<b>Description</b>
① PCIE1	PCIe x16 slot
②③④⑤ PCI	PCI slot
⑥⑦ DCOUT1, 2	VGA12V power output connector
⑧⑨⑩ FAN1-3	Fan power connector
⑪ DCIN2	System power input connector
⑫ SATA1, 2	Serial SATA connector
⑬ PWROUT1, 2	SATA HDD power connector

### 3.2. Pinheaders and Connectors

#### 3.2.1. Pinheaders



##### ① JME1

**Function:** Clear CMOS Selection  
**Jumper Type:** 2.00mm pitch, 1x2-pin header  
**Setting:**

Pin	Description	
Short	Clear CMOS	
Open	Keep CMOS (default)	



##### ② JACCON1

**Function:** ACC ON Mode selection(for debug)  
**Jumper Type:** 2.00mm pitch, 1x2-pin header  
**Setting:**

Pin	Description	
Short	ACC ON Mode	
Open	Car mode	

##### ③ JDIO

**Function:** Digital I/O VCC out put voltage  
**Jumper Type:** Onboard 2.00mm-pitch 1x3-pin header  
**Setting:**

Pin	Description	
Short 1-2	12V	
Short 2-3	5V (default)	

### 3.2.2. Connectors

#### 3.2.2.1 Main board

##### ①⑩ FAN Connector (SYSFAN1/CPUFAN1)

**Function:** Fan Power Connector

**Connector Type:** Onboard 2.54mm pitch 1x4-pin one-wall wafer connector

**Pin Assignment:** **Pin Description**

1	GND
2	+12V
3	RPM
4	Control



##### ② System reset pin header (JSW1): Reserved for Reset button

**Function:** Reserved for Reset button

**Connector Type:** onboard 2.0mm pitch 2-pin header

**Pin Assignment:** **Pin Description**

1	FR_RST#
2	GND



##### ③ DGP1

**Function:** External 80 port

**Connector Type:** 2.00mm-pitch 2x5-pin header

**Pin Assignment:** **Pin Description**      **Pin Description**

1	CLK	2	GND
3	FRAME#	4	LAD0
5	PLTRST#	6	N.C
7	LAD3	8	LAD2
9	VCC3	10	LAD1

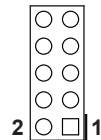

④ Vcore IC debug pin header (JPIC2)

**Function** Reserved For Vcore IC debug

**Connector Type:** Onboard 2.0mm pitch 6-pin header

**Pin Assignment:**

Pin	Description	Pin	Description
1	NC	2	NC
3	GND	4	PMSCL
5	nPMALERT	6	PMSDA



⑤ POEOUT1

**Function:** PoE Power Connector

**Connector Type:** 2.54mm-pitch 4-pin header

**Pin Assignment:**

Pin	Desc.
1	GND
2	GND
3	DCIN
4	DCIN

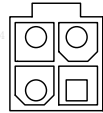

⑥ SW2

**Function** Power Button

**Connector Type:** Onboard 2x1-pin box connector

**Pin Assignment:**

Pin	Description
1	PWR_IN_SW#
2	GND

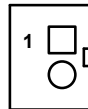



⑦ JACCON2

**Function:** Ignition Power Connector  
**Connector Type:** Onboard 2x1-pin box connector  
**Pin Assignment:**

Pin	Description
1	Acc_ON
2	GND

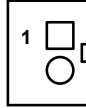

⑧ DIO1

**Function:** Digital IO Connector  
**Connector Type:** 2.0mm pitch 2x13 pin box header  
**Pin Assignment:**

Pin	Desc.	Pin	Desc
1	DIO0	14	DIO8
2	DIO1	15	DIO9
3	DIO2	16	DIO10
4	DIO3	17	DIO11
5	DIO4	18	DIO12
6	DIO5	19	DIO13
7	DIO6	20	DIO14
8	DIO7	21	DIO15
9	+5V	22	GND
10	+5V	23	GND
11	N.C	24	N.C
12	N.C	25	N.C
13	N.C	26	N.C



⑨ LPT1

**Function:** On-board Parallel Port Connector  
**Connector Type:** 2.00mm pitch 2 x13-pin box header  
**Pin Assignment:**

Pin	Desc.	Pin	Desc.
1	STB#	14	AFD#
2	PD0	15	ERR#
3	PD1	16	INIT#
4	PD2	17	SLIN#
5	PD3	18	GND
6	PD4	19	GND
7	PD5	20	GND
8	PD6	21	GND
9	PD7	22	GND
10	ACK#	23	GND
11	BUSY	24	GND
12	PE	25	GND
13	SLCT	26	N.C



⑩ SIM

**Function:** SIM Card Socket  
**Connector Type:** 6-pin SIM card socket  
**Pin Assignment:**

Pin	Desc.	Pin	Desc.
C1	VCC	C2	RST
C3	CLK	C5	GND
C6	VPP	C7	I/O

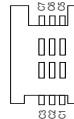

⑫ **VGA2**

**Function:** Analog RGB  
**Connector Type:** Analog RGB(D-Sub 15-pin female type)  
**Pin Assignment:**

Pin	Desc.	Pin	Desc.
1	RED	9	+5V
2	GREEN	10	GND
3	BLUE	11	N/C
4	N/C	12	VDDAT
5	GND	13	HSYNC
6	GND	14	VSYNC
7	GND	15	VDCLK
8	GND		

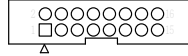

⑬ **MEKEY1**

**Function:** M.2 E-Key socket (w/ PCIe + USB 2.0) for optional Wi-Fi/BT  
**Connector Type:** M.2 E-Key 2230 Socket  
**Pin Assignment:** The pin assignments conform to the industry standard.

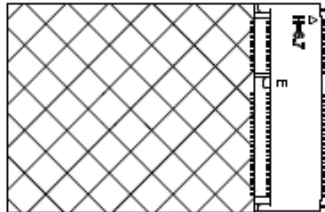

⑭ **MC2**

**Function:** PCI Express Mini-card Full socked  
**Connector Type:** Onboard 0.8mm pitch 52-pin edge card connector.  
**Pin Assignment:**

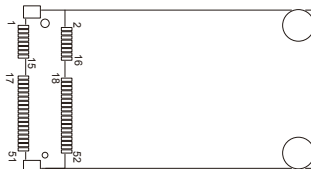

## ⑮ USB1

**Function:** USB 2.0/3.0 connectors  
**Connector Type:** USB2.0/3.0 Type-A connectors  
**Pin Assignment:** The Pin assignment conform to the industry standard.

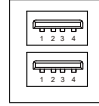

## ⑯ LAN2

**Function:** Dual GbE RJ-45 Ethernet connectors  
**Connector Type:** RJ-45 connector that supports 10/100/1000Mbps fast Ethernet  
**Pin Assignment:** The Pin assignment conform to the industry standard.



## ⑰ SMBUS Connector(JSMB1)

**Function:** SMbus Wafer connector for DIO  
**Connector Type:** 1.25mm pitch 1x6 wafer connector  
**Pin Assignment:**

Pin	Desc.
1	+V3.3S
2	GND
3	CLK
4	GND
5	DATA
6	+V12S

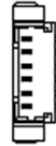

## ⑱ BAT1

**Function:** RTC Battery  
**Connector Type:** Onboard 2x1-pin box connector  
**Pin Assignment:**

Pin	Desc.
1	BAT+
2	BAT-



⑲ **VGACARDPWR01**

**Function:** VGA card power  
**Connector Type:** onboard 2.54mm pitch 4-pin wafer  
**Pin Assignment:**

Pin	Desc.
1	GND
2	GND
3	+V12S
4	+V12S

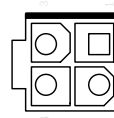

⑳ ㉑ **USB4, 5**

**Function:** USB 3.0/2.0 Connectors  
**Connector Type:** On-board 1.25mm pitch 1x5 pin wafer connector  
**Pin Assignment:**

Pin	Description.
1	+5V
2	D-
3	D+
4	GND
5	GND



㉒ **SIM**

**Function:** SIM Card Socket  
**Connector Type:** 6-pin SIM card socket  
**Pin Assignment:**

Pin	Desc.	Pin	Desc
C1	VCC	C2	RST
C3	CLK	C5	GND
C6	VPP	C7	I/O

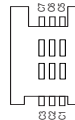

### ②③ MBKEY1

**Function:** M.2 B-Key socket (w/ PCIe + USB 3.0 or SATA + USB 3.0)(either one)

**Connector Type:** M.2 B-Key

**Pin Assignment:** The pin assignments conform to the industry standard.

### ②④ ②⑤ COM4, 5

**Function:** RS232 Connector(COM4~COM5)

**Connector Type:** Onboard 1.25mm pitch 9-pin Connector

**Pin Assignment:**

Pin	Description
1	XDCD#
2	XDSR#
3	XRXD
4	XRTS#
5	XTXD
6	XCTS#
7	XDTR#
8	XRI#
9	GND

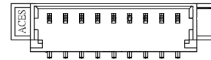

②⑥ ②⑦ **COM6, 7**

**Function:** RS232/RS422/RS485 connector(COM6~COM7)

**Connector Type:** Onboard 1.25mm pitch 9-pin Connector

**Pin Assignment:**

Pin	Description
1	XDCD#
2	XDSR#
3	XRXD
4	XRTS#
5	XTXD
6	XCTS#
7	XDTR#
8	XRI#
9	GND



②⑧ **SYSFAN2**

**Function:** System Fan power out

**Connector Type:** 2.0mm-pitch 2-pin header

**Pin Assignment:**

Pin	Description
1	+12V
2	GND



②⑨ **PCIE1**

**Function:** PCIe x 8 slot

**Pin Assignment:** ARBOR pin define



⑩ **PCIE2**

**Function:** PCIe x16 slot

**Pin Assignment:** The pin assignments conform to the industry standard.

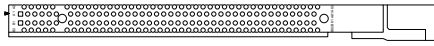

**3.2.2.2 Riser board - SCDB-649Y**

① **PCIE1**

**Function:** PCIe x16 slot

**Pin Assignment:** The pin assignments conform to the industry standard.

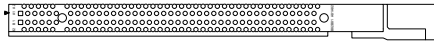

②③④⑤ **PCI**

**Function:** PCI slot

**Pin Assignment:** The pin assignments conform to the industry standard.

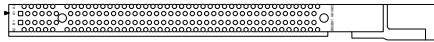

⑥⑦ **DCOUT1,2**

**Function:** Power Connector

**Connector Type:** onboard 2.54mm pitch 8-pin wafer

**Pin Assignment:**

Pin Desc.	Pin Desc.
1 GND1	5 +12V_5
2 SENSE0	6 +12V_6
3 GND3	7 +12V_7
4 GND4	8 SENSE1

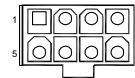



⑧ ⑨ ⑩ **FAN1-3**

**Function:** Fan Power Connector

**Connector Type:** Onboard 2.54mm pitch 1x4-pin one-wall wafer connector.

**Pin Assignment:**

Pin	Pin Description
1	GND
2	+12V
3	RPM
4	Control



⑪ **DCIN (DCIN2)**

**Function:** DC in

**Connector Type:** onboard 2.54mm pitch 8-pin wafer

**Pin Assignment:**

Pin	Pin Description
1	GND
2	GND
3	GND
4	GND
5	+12V_5
6	+12V_6
7	+12V_7
8	+12V_8

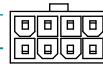

⑩ ⑪ **SATA1, 2**

**Function:** Serial ATA Connector

**Connector Type:** On-board Standard 7-pin Serial ATA Connector

**Pin Assignment:**

Pin	Description
1	GND
2	TX+
3	TX-
4	GND
5	RX-
6	RX+
7	GND



### ⑫ ⑬ PWROUT1, 2

**Function:** SATA HDD Power Connector

**Connector Type:** 2.54mm pitch 1x4-pin one-wall connector

**Pin Assignment:**

Pin	Description
1	+5V
2	GND
3	GND
4	+12V

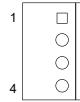

---

Please note that the rest of the connectors and pins on the SCDB-649Y R01 are for other computers.

FPC-9108-P6-G3

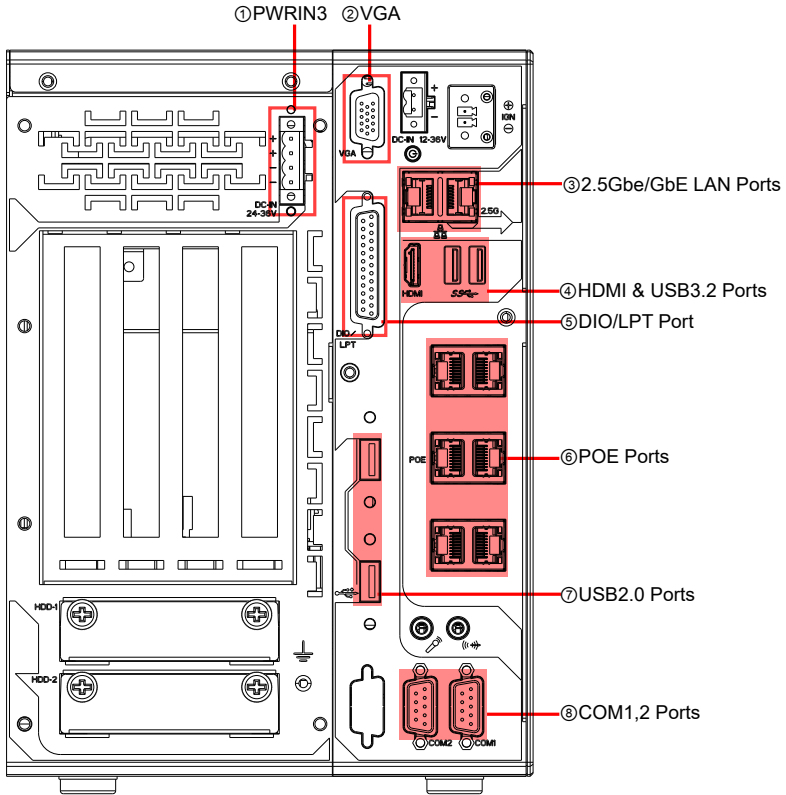

### ① PWRIN3

**Function:** DC Adapter Power Input for expansion card

**Connector Type:** 4-Pin Terminal block

**Pin Assignment:**

Pin	Desc.
1	V+
2	V+
3	V-
4	V-

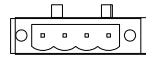

### ② VGA

**Function:** Analog RGB & DVI-D Connector

**Connector Type:** Analog RGB (D-Sub 15-pin female type)

Analog RGB



**Pin Assignment:**

**Analog RGB Connector**

Pin	Desc.	Pin	Desc.	Pin	Desc.
1	RED	6	GND	11	N/C
2	GREEN	7	GND	12	VDDAT
3	BLUE	8	GND	13	HSYNC
4	N/C	9	+5V	14	VSYNC
5	GND	10	GND	15	VDCLK

### ③ 2.5GbE/GbE LAN Ports

**Function:** Dual GbE RJ-45 Ethernet connectors

**Connector Type:** RJ-45 connector that supports 10/100/1000M/2.5Gbps fast Ethernet

**Pin Assignment:** The Pin assignment conform to the industry standard.



④ HDMI & USB3.2 Ports

**Function:** HDMI Connectors (includes USB Connectors)

**Connector Type:** HDMI + double stacked USB type A connector

**Pin Assignment:** The Pin assignment conform to the industry standard.

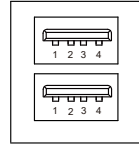

⑤ DIO/LPT Port (Default DIO)

**Function:** Digital IO Connector

**Connector Type:** 2.0mm pitch 25 pin box header

**Pin Assignment:**

Pin	Desc.	Pin	Desc
1	DIO0	14	DIO8
2	DIO1	15	DIO9
3	DIO2	16	DIO10
4	DIO3	17	DIO11
5	DIO4	18	DIO12
6	DIO5	19	DIO13
7	DIO6	20	DIO14
8	DIO7	21	DIO15
9	+5V	22	GND
10	+5V	23	GND
11	N.C	24	N.C
12	N.C	25	N.C
13	N.C		

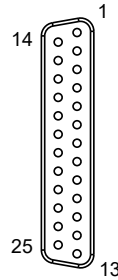

⑥ POE Ports

**Function:** RJ-45 connector

**Connector Type:** RJ-45 connector that supports PoE

**Pin Assignment:** The Pin assignment conform to the industry standard.



## ⑦ USB2.0 Ports

**Function:** HDMI Connectors (includes USB Connectors)

**Connector Type:** HDMI + double stacked USB type A connector

**Pin Assignment:** The Pin assignment conform to the industry standard.

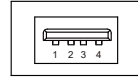

## ⑧ COM1, COM2

**Function:** RS-232/422/485 Selectable Serial Port

**Connector Type:** External 9-pin D-sub male connector

**Pin Assignment:**

	Pin	Desc.	Pin	Desc
<b>RS-232</b>	1	DCD	6	DSR
	2	RXD	7	RTS
	3	TXD	8	CTS
	4	DTR	9	RI
	5	GND		
<b>RS-422</b>	1	COM_422 TX-		
	2	COM_422 TX+		
	3	COM_422 RX+		
	4	COM_422 RX-		
	5	GND		
<b>RS-485</b>	1	COM_485 D-		
	2	COM_485 D+		
	5	GND		

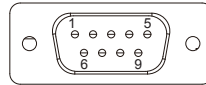

FPC-9108-L2U4-G3

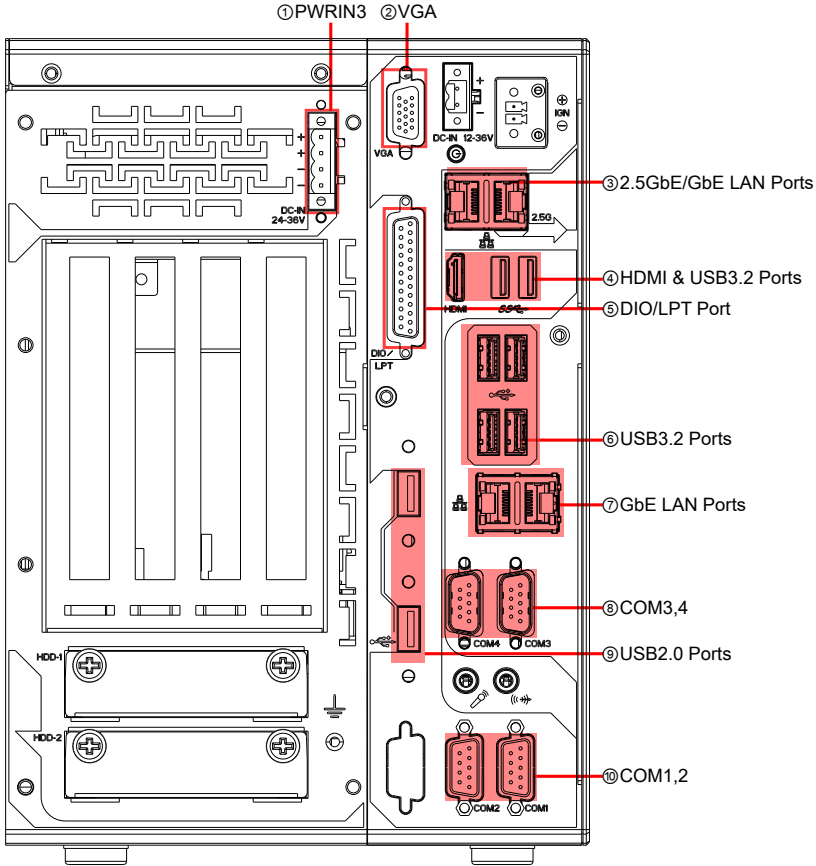

### ① PWRIN3

**Function:** DC Adapter Power Input for expansion card

**Connector Type:** 4-Pin Terminal block

**Pin Assignment:**

Pin	Desc.
1	V+
2	V+
3	V-
4	V-

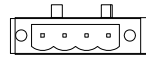

### ② VGA

**Function:** Analog RGB & DVI-D Connector

**Connector Type:** Analog RGB (D-Sub 15-pin female type)

Analog RGB



**Pin Assignment:**

**Analog RGB Connector**

Pin	Desc.	Pin	Desc.	Pin	Desc.
1	RED	6	GND	11	N/C
2	GREEN	7	GND	12	VDDAT
3	BLUE	8	GND	13	HSYNC
4	N/C	9	+5V	14	VSYNC
5	GND	10	GND	15	VDCLK

### ③ 2.5GbE/GbE LAN Ports

**Function:** Dual GbE RJ-45 Ethernet connectors

**Connector Type:** RJ-45 connector that supports 10/100/1000Mbps/2.5Gbps fast Ethernet

**Pin Assignment:** The Pin assignment conform to the industry standard.





④ **HDMI & USB3.2 Ports**

**Function:** HDMI Connectors (includes USB Connectors)

**Connector Type:** HDMI + double stacked USB type A connector

**Pin Assignment:** The Pin assignment conform to the industry standard.

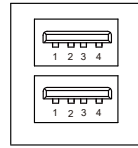

⑤ **DIO/LPT Port** (Default DIO)

**Function:** Digital IO Connector

**Connector Type:** 2.0mm pitch 25 pin box header

**Pin Assignment:**

Pin	Desc.	Pin	Desc
1	DIO0	14	DIO8
2	DIO1	15	DIO9
3	DIO2	16	DIO10
4	DIO3	17	DIO11
5	DIO4	18	DIO12
6	DIO5	19	DIO13
7	DIO6	20	DIO14
8	DIO7	21	DIO15
9	+5V	22	GND
10	+5V	23	GND
11	N.C	24	N.C
12	N.C	25	N.C
13	N.C		

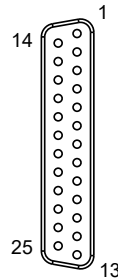

⑥ **USB3.2 Ports**

**Function:** HDMI Connectors (includes USB Connectors)

**Connector Type:** HDMI + double stacked USB type A connector

**Pin Assignment:** The Pin assignment conform to the industry standard.

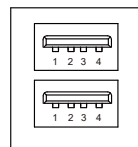

## Engine of the Computer

---

### ⑦ GbE LAN Ports

**Function:** RJ-45 connector  
**Connector Type:** RJ-45 connector  
**Pin Assignment:** The Pin assignment conform to the industry standard.



### ⑧ COM3, COM4

**Function:** RS-232 Selectable Serial Port  
**Connector Type:** External 9-pin D-sub male connector  
**Pin Assignment:**

	Pin	Desc.	Pin	Desc
RS-232	1	DCD	6	DSR
	2	RXD	7	RTS
	3	TXD	8	CTS
	4	DTR	9	RI
	5	GND		

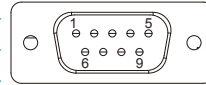

### ⑨ USB2.0 Ports

**Function:** HDMI Connectors (includes USB Connectors)  
**Connector Type:** HDMI + double stacked USB type A connector  
**Pin Assignment:** The Pin assignment conform to the industry standard.

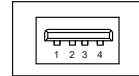

⑩ **COM1, COM2**

**Function:** RS-232/422/485 Selectable Serial Port

**Connector Type:** External 9-pin D-sub male connector

**Pin Assignment:**

	Pin	Desc.	Pin	Desc
<b>RS-232</b>	1	DCD	6	DSR
	2	RXD	7	RTS
	3	TXD	8	CTS
	4	DTR	9	RI
	5	GND		
<b>RS-422</b>	1	COM_422 TX-		
	2	COM_422 TX+		
	3	COM_422 RX+		
	4	COM_422 RX-		
	5	GND		
<b>RS-485</b>	1	COM_485 D-		
	2	COM_485 D+		
	5	GND		

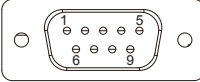

---

This page is intentionally left blank.

---

# Chapter 4

## Installation and Maintenance

### 4.1. Install Hardware

The FPC-9108 Series is constructed based on modular design to make it easy for users to add hardware or to maintain the computer. The following sections will guide you to the simple hardware installations for the computer.

#### 4.1.1. Open the Computer

For the computer, removing the top and bottom covers is essential to open the computer and access the inside. Follow through the steps below to remove the top cover and bottom cover from the computer.

##### 4.1.1.2. Remove Top Cover

All jumpers, CPU socket, MiniCard socket, SDRAM SO-DIMM slots, DIO/ LPT ports are built on the top side of the main board. To access these components, the computer's top cover has to be removed. Follow through the steps below to remove the top cover.

#### FPC-9108-P6-G3

This section will use FPC-9108-P6-G3 as the installation example.

1. Loosen and remove the 4 screws as shown below.



2. Loosen and remove the 3 screws on the top panels respectively as shown below.

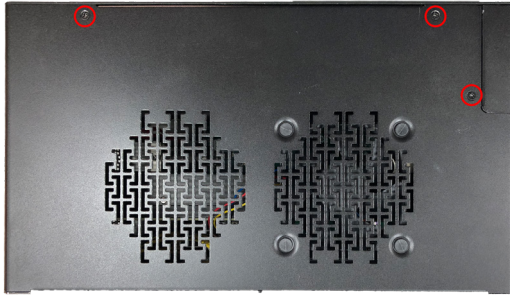

3. Carefully lift the top cover and then completely part the top and slide the side cover from the computer.

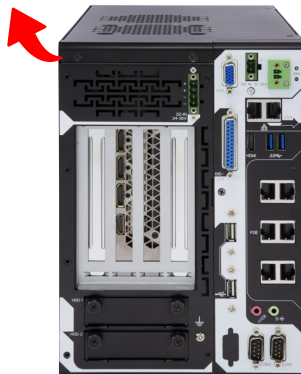

The inside of the computer comes to view.

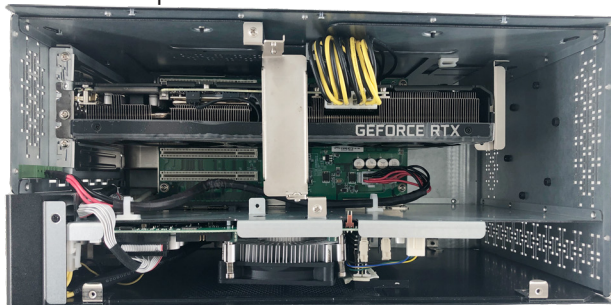

## Installation & Maintenance

---

### 4.1.1.3. Remove Side Cover

1. Loosen and remove the 2 screws at the bottom as shown below.



2. Loosen and remove the 3 screws on the top panels respectively as shown below.

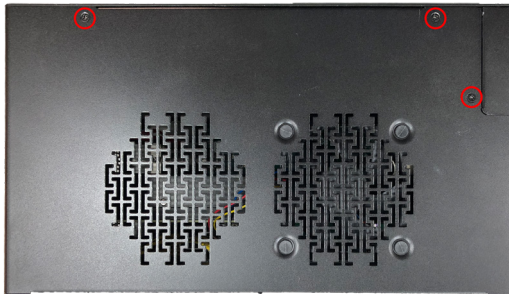

3. Carefully slide the side over and then completely part the side cover from the computer.

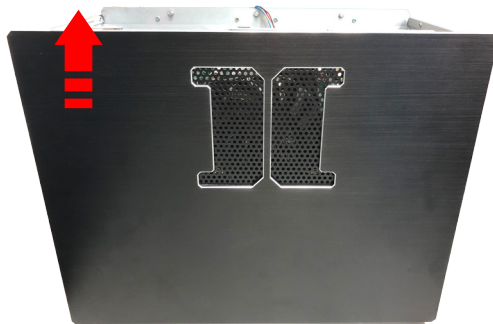



The inside of the computer comes to view.



#### 4.1.2. Install CPU

1. Remove the top and side cover from the computer as described in [4.1.1.3. Remove Side Cover](#) on page [52](#).
2. Locate the CPU socket on the main board

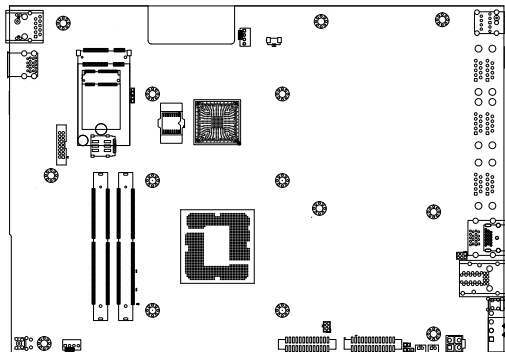

## Installation & Maintenance

---

The processor socket comes with a lever to secure the processor. Please refer to the pictures step by step as below and note that the cover of the socket must always be installed during transportation to avoid damage to the socket.

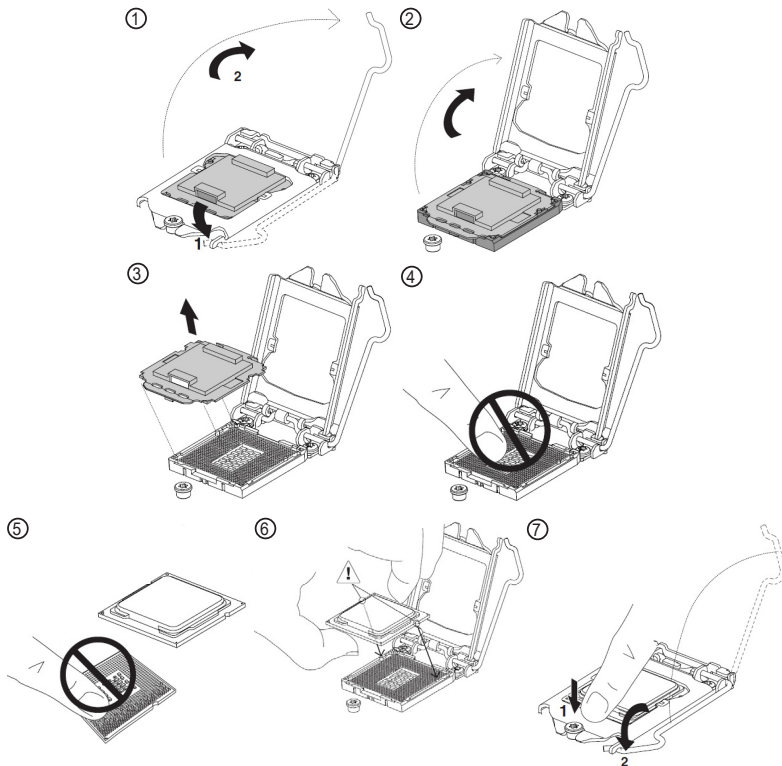

3. Restore the top and side cover to the computer by fastening the all screws.

### 4.1.3. Install/Uninstall Memory Modules

The main board has two memory module (DIMM) sockets. Increase memory capacity to make programs run faster on the system. The memory module for the FPC-9108 Series' SO-DIMM sockets should be a 260-pin DDR4 with a "key notch" off the centre among the pins, which enables the memory module for particular applications. There are another two notches at each left and right side of the memory module to help fix the module in the socket.

---

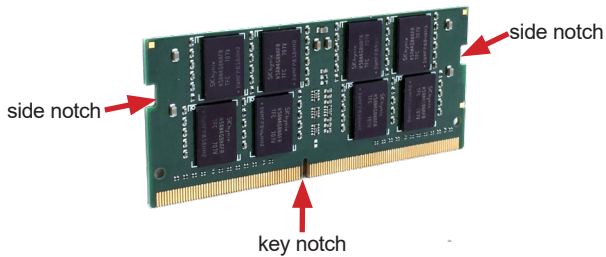

**To install a DDR4 memory module:**

1. Remove the side cover from the computer as described in [Section 4.1.1.3. Remove Side Cover on page 52.](#)
2. Locate the SO-DIMM sockets on the main board.

The SO-DIMM sockets are vertical type, and each socket has two latches for fixing the memory modules. The memory module can only be installed by one direction due to the notch.

3. Pull back both latches from the socket.

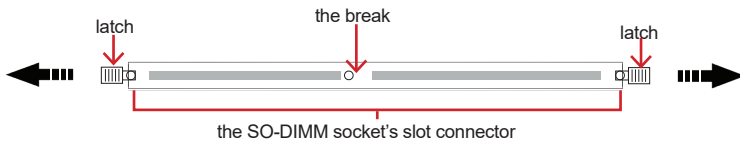

vertical-type SO-DIMM socket (overview)

4. Confront the memory module's edge connector side at the SO-DIMM socket. Position the memory module at the SO-DIMM socket, with the memory module's key notch aligned at the break of the SO-DIMM's slot connector.

## Installation & Maintenance

---

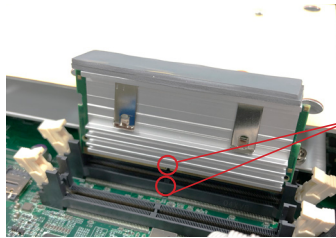

Align the notch on the memory module with the notch in the memory socket.

5. Vertically plug the memory module to the DIMM socket. “Fully” plug the memory module until both latches auto-lock the memory module in place.

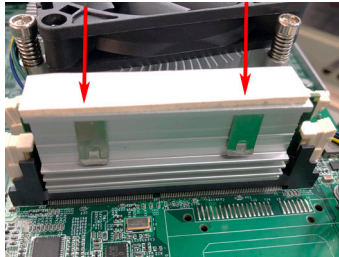

6. Restore the top and side cover to the computer.

**To uninstall a DDR4 memory module:**

1. Pull back both latches from the SO-DIMM socket.

The DDR4 memory module will be auto-released from the socket.

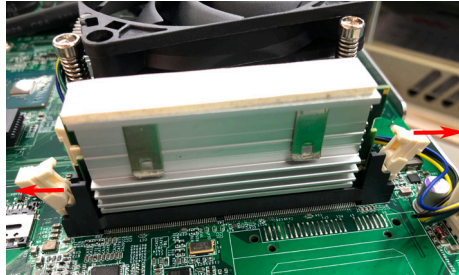

2. Remove the memory module.
3. Restore the top cover to the computer.

### 4.1.4. Install Wi-Fi Module

1. Remove the side cover from the computer as described in [Section 4.1.1.3. Remove Side Cover on page 52.](#)
2. Locate the **M.2 E-Key** socket for wireless module.

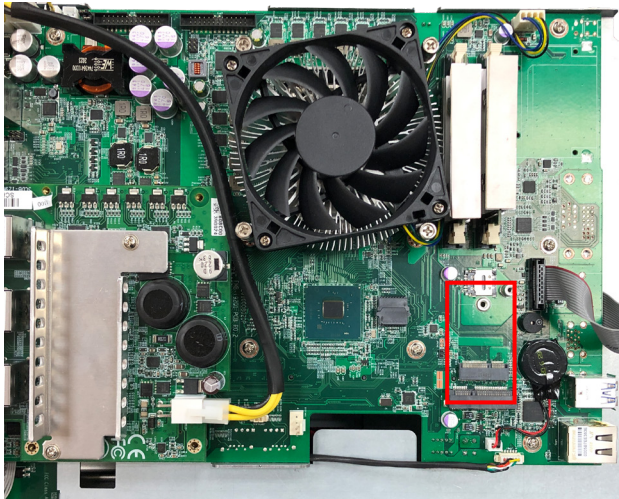

3. Prepare the Wi-Fi module kit. The module is a **M.2 E-Key** socket form factor, with two MHF connectors, one is "MAIN", and the other is "AUX".

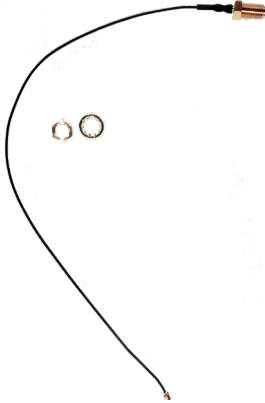

Two MHF connectors, one is “MAIN” (marked 2), the other is “AUX” (marked 1).



4. Have the RF antenna. The antenna has an SMA connector on one end and an MHF connector on the other.

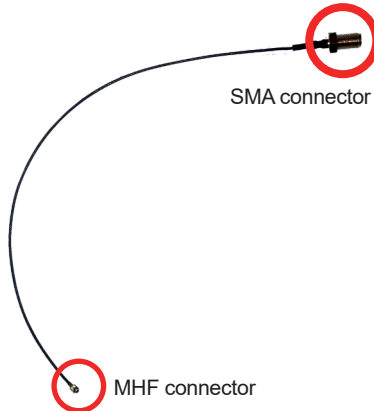

5. Connect the RF antenna’s MHF connector to the Wi-Fi module’s main connector marked 0. If you are going to connect a secondary antenna, connect it to the connector marked 1.

## Installation & Maintenance

---

Connect the RF antenna's MHF connector to the Wi-Fi module's main connector (marked 2)

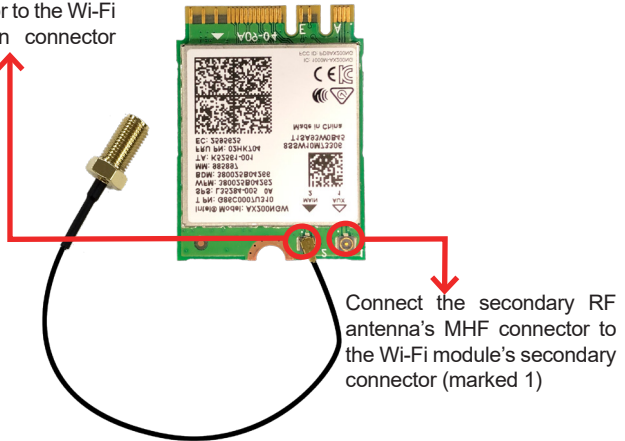

6. Plug the Wi-Fi module to the socket's connector by a slanted angle. Fully plug the module, and note the notch on the wireless module should meet the break of the connector.



The module's key notch should meet the connector's break.

7. Press the module down and fix the module in place using one screw.



8. Locate the SMA antenna holes on front panel. Remove the plastic plug to
-



make an antenna hole. Keep the plastic plug for any possible restoration in the future.

- From the other end of the RF antenna, which is an SMA connector, remove the washer and the nut. Note the SMA connector has the form of a threaded bolt, with one flat side.

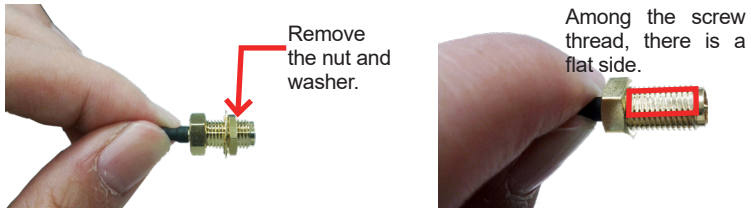

- Pull the SMA connector through the above mentioned antenna hole. Note to meet the aforesaid flattened side with the antenna hole's flat side.

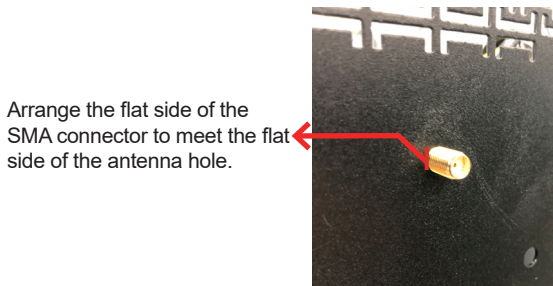

- Mount the washer first and then the nut to the SMA connector. Make sure the nut is tightened.

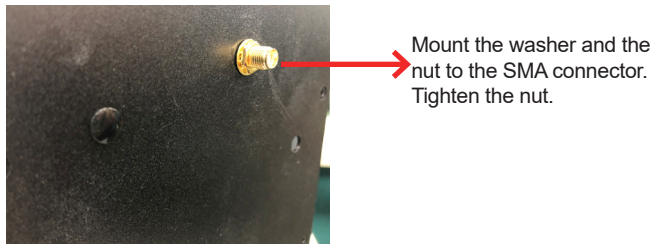

## Installation & Maintenance

---

12. Have the external antenna(s). Screw and tightly fasten the antenna(s) to the SMA connector.



### 4.1.5. Install Internal SATA Storage Device

The computer supports two 2.5" SATA storage devices to work inside the computer for RAID. The following will guide you to install two SATA HDD/SSD.

1. Find the HDD/SSD brackets. Loosen the screws as marked in the illustration below and take the bracket out. Then dismount the bracket from the computer.

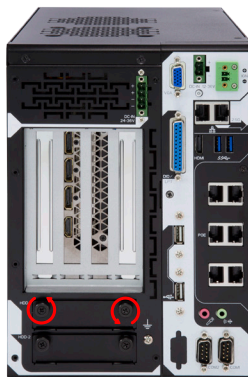

2. For the 1st storage bracket, slide the HDD/SSD storage device into the bracket.



3. Fix the storage device in place by fastening the four screws of the bracket.

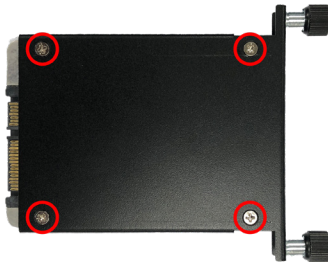

4. If you are going to install the 2nd HDD/SSD storage device, slide the storage device into the bracket and fix it in place in the same way.
5. Restore the HDD/SSD bracket to the computer.

### 4.1.6. Install PCI and PCI Express Cards

To install a PCI or PCI Express card:

1. Remove the top cover from the computer as described in section [Section 4.1.1.2. Remove Top Cover on page 50.](#)
2. Use a cross head screwdriver to loose the screw that secure the expansion slot bracket. And then you can install a PCIe card to this expansion slot.



3. Restore the side and bottom cover to the computer.

#### 4.1.7. Install graphic cards

To install a graphic cards:

1. Remove the top and side cover from the computer.
2. Install the L-type rack on your graphic card and tighten the screws to secure it as shown below.



---

**Note:** Please note that the rack screws hole depends on different graphic cards.

3. Assemble the main rack and fix the screws as shown below.

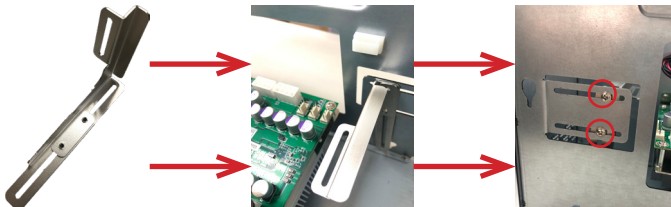

## Installation & Maintenance

---

4. Locate the PCIe slot on the riser card and install a graphic card into the computer.

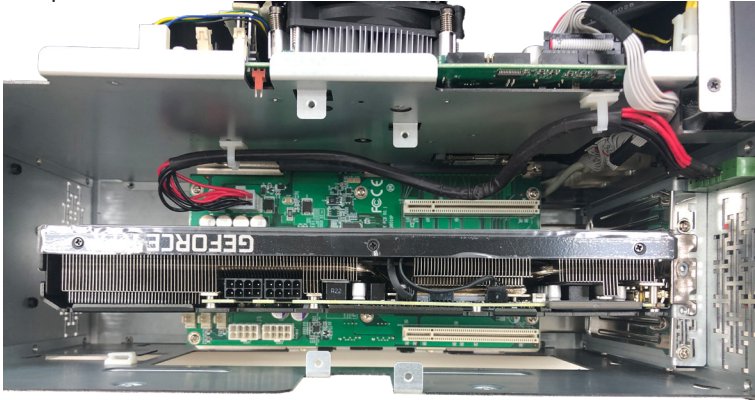

5. Use a cross head screwdriver to tighten the screws to secure the graphic card.

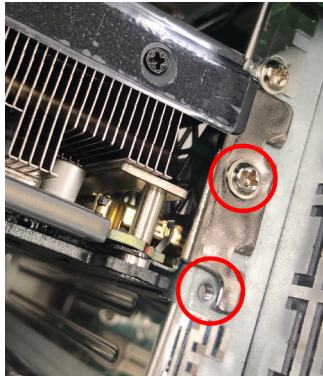

6. Adjust the rack in the computer to reach the graphic card and secure the rack as the picture below.

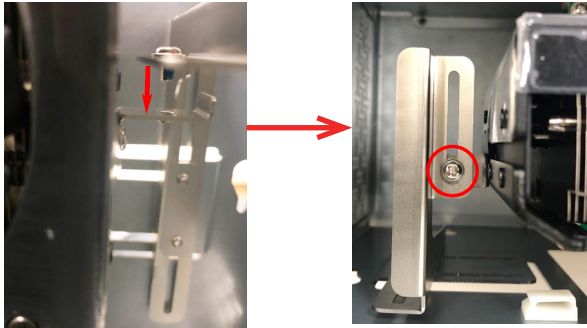

7. Plug the power plug of graphic card to computer.

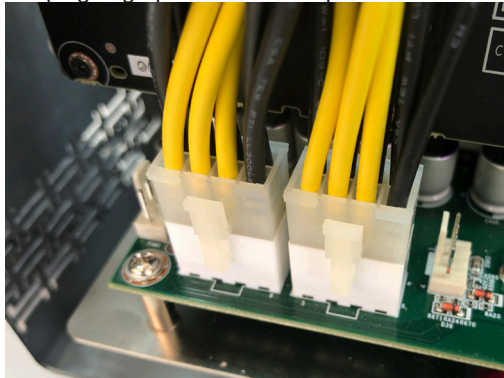

## Installation & Maintenance

---

8. Use a cross-head screwdriver to tighten the screws to secure the graphic card holder.

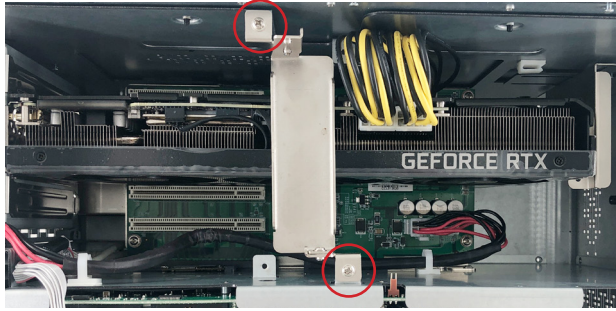

9. Restore the top and side cover to the computer.



#### 4.1.8. Install/Uninstall SIM Card

This section will use FPC-9108-P6-G3 as the example to guide you through the SIM card installation steps:

1. Remove the side cover from the computer as described in [Section 4.1.1.3. Remove Side Cover on page 52.](#)
2. Locate the SIM card slot on the main board.

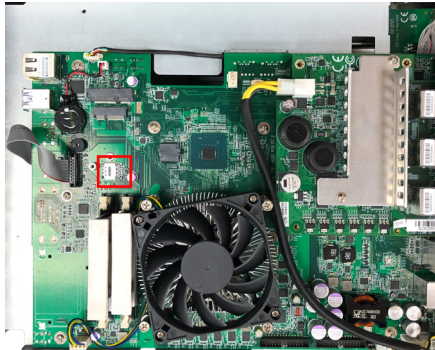

3. Slide the SIM card holder cover towards the OPEN edge and then lift the cover to open it.

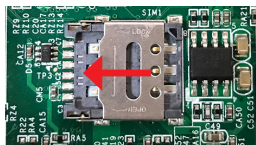

4. Insert the SIM card into the card holder as shown below.



## Installation & Maintenance

---

5. Close the SIM card holder door and slide the door to the LOCK edge to lock into place.

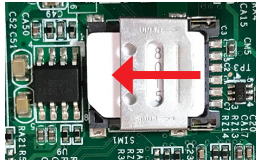

### To uninstall the SIM card:

1. Loosen and remove the card door screw and open the card door.
2. Push-eject the SIM card.
3. Remove the SIM card.
4. Refasten the screw to close the card door.

Note: Make sure to refasten the screw to close the card door each time the SIM card is installed or uninstalled.

## 4.2. Wire DC-in Power Source

### 4.2.1 Automation Mode

Follow the instructions below for connecting the computer to a DC-input power source.



**Warning** Only trained and qualified personnel are allowed to install or replace this equipment.

1. Before wiring, make sure the power source is disconnected.
2. Find the terminal block in the accessory box.
3. Use the wire-stripping tool to strip a short insulation segment from the output wires of the DC power source.
4. Identify the positive and negative feed positions for the terminal block connection. See the symbols printed on the rear panel indicating the polarities and DC-input power range in voltage.
5. Insert the exposed wires into the terminal block plugs. Only wires with

insulation should extend from the terminal block plugs. Note that the polarities between the wires and the terminal block plugs must be positive to positive and negative to negative.

6. Use a slotted screwdriver to tighten the captive screws. Plug the terminal block firmly, which wired, into the receptacle on the rear panel.



### 4.2.2 Vehicle Application Mode

Follow the instructions below for connecting the computer to a vehicle power source.

1. Make sure JACCON2 jumper is open for vehicle power mode. (Refer to [Section 3.2.1. Pinheaders on page 26](#).)
2. For vehicle application, DC power Input wiring pin configuration is as below. Please connect the Acc pin with your car Acc, and the device will be activated when you turn your ignition key to Acc.

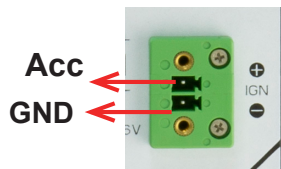

---

This page is intentionally left blank.

---

# Chapter 5

## BIOS

## BIOS

The BIOS Setup utility for the FPC-9108 Series is featured by American Megatrends Inc to configure the system settings stored in the system's BIOS ROM. The BIOS is activated once the computer powers on. When the computer is off, the battery on the main board supplies power to BIOS RAM.

To enter the BIOS Setup utility, keep hitting the “Delete” key upon powering on the computer.



The featured settings are:

Menu	Description
Main	See <a href="#">5.1. Main on page 76</a>
Advanced	See <a href="#">5.2. Advanced on page 77</a>
Chipset	See <a href="#">5.3. Chipset on page 92</a>
Security	See <a href="#">5.4. Security on page 98</a>
Boot	See <a href="#">5.5. Boot on page 100</a>
Save & Exit	See <a href="#">5.6. Save &amp; Exit on page 102</a>

## Key Commands

The BIOS Setup utility relies on a keyboard to receive user's instructions. Hit the following keys to navigate within the utility and use the utility.

Keystroke	Function
← →	Moves left/right between the top menus.
↓ ↑	Moves up/down between highlight items.
<b>Enter</b>	Selects an highlighted item/field.
<b>Esc</b>	<ul style="list-style-type: none"> <li>▶ On the top menus: Use <b>Esc</b> to quit the utility without saving changes to CMOS. (The screen will prompt a message asking you to select <b>OK</b> or <b>Cancel</b> to exit discarding changes.</li> <li>▶ On the submenus: Use <b>Esc</b> to quit current screen and return to the top menu.</li> </ul>
<b>Page Up / +</b>	Increases current value to the next higher value or switches between available options.
<b>Page Down / -</b>	Decreases current value to the next lower value or switches between available options.
<b>F1</b>	Opens the <b>Help</b> of the BIOS Setup utility.
<b>F2</b>	Previous values
<b>F9</b>	Optimized defaults
<b>F10</b>	Exits the utility saving the changes that have been made. (The screen then prompts a message asking you to select <b>OK</b> or <b>Cancel</b> to exit saving changes.)

Note: Pay attention to the "WARNING" that shows at the left pane onscreen when making any change to the BIOS settings.

This BIOS Setup utility is updated from time to time to improve system performance and hence the screenshots hereinafter may not fully comply with what you actually have onscreen.

# BIOS

## 5.1. Main

The **Main** menu features the settings of **System Date** and **System Time** and displays some BIOS info.



The featured settings are:

Setting	Description
<b>System Date</b>	Set the system date. Use Tab to switch between Data elements. Note that the 'Day' automatically changes when you set the date. ▶ The date format is: <b>Day:</b> Sun to Sat <b>Month:</b> 1 to 12 <b>Date:</b> 1 to 31 <b>Year:</b> 1998 to 2099
<b>System Time</b>	Set the system time. Use Tab to switch between Time elements. ▶ The time format is: <b>Hour:</b> 00 to 23 <b>Minute:</b> 00 to 59 <b>Second:</b> 00 to 59



## 5.2. Advanced

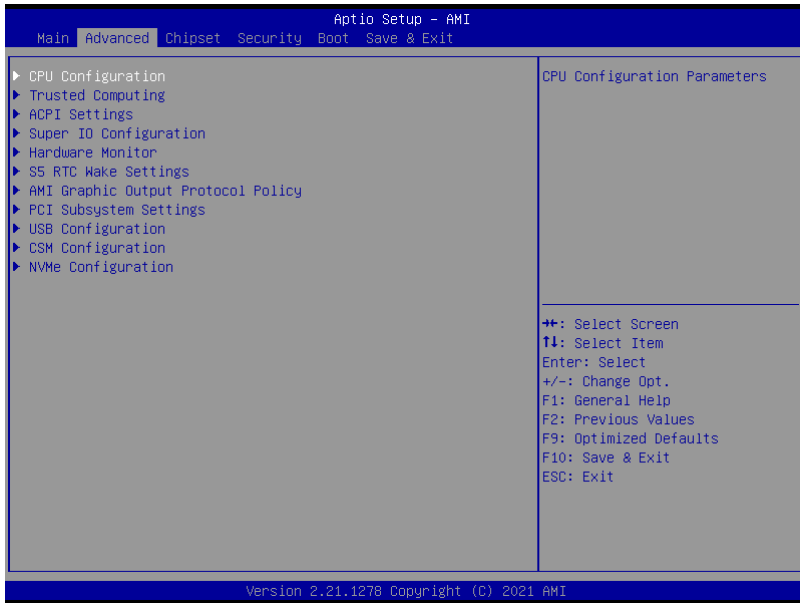

The featured settings and submenus are:

Setting	Description
<b>CPU Configuration</b>	See <a href="#">5.2.1. CPU Configuration</a> on page <a href="#">78</a>
<b>Trusted Computing</b>	See <a href="#">5.2.2. Trusted Computing</a> on page <a href="#">80</a>
<b>ACPI Settings</b>	See <a href="#">5.2.3. ACPI Settings</a> on page <a href="#">81</a>
<b>Super IO Configuration</b>	See <a href="#">5.2.4. Super IO Configuration</a> on page <a href="#">82</a>
<b>Hardware Monitor</b>	See <a href="#">5.2.5. Hardware Monitor</a> on page <a href="#">84</a>
<b>SS RTC Wake Settings</b>	See <a href="#">5.2.6. S5 RTC Wake Settings</a> on page <a href="#">85</a>
<b>AMI Graphic Outut protocol policy</b>	See <a href="#">5.2.7. AMI Graphic Outut protocol policy</a> on page <a href="#">86</a>
<b>PCI Subsystem Settings</b>	See <a href="#">5.2.8. PCI Sybssystem Settings</a> on page <a href="#">87</a>
<b>USB Configuration</b>	See <a href="#">5.2.9. USB Configuration</a> on page <a href="#">88</a>
<b>CSM Configuration</b>	See <a href="#">5.2.10. CSM Configuration</a> on page <a href="#">90</a>
<b>NVMe Configuration</b>	See <a href="#">5.2.11. NVMe Configuration</a> on page <a href="#">91</a>

### 5.2.1. CPU Configuration

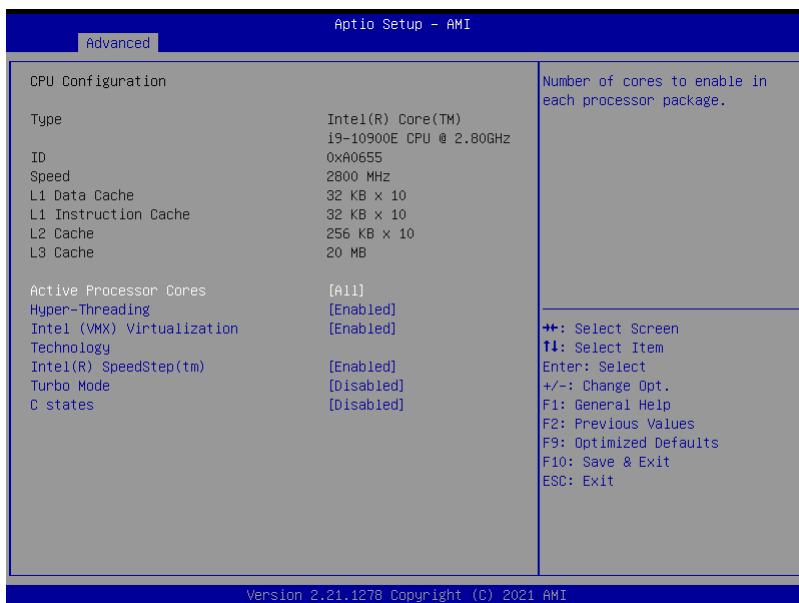

The features settings are:

Setting	Description
<b>Active Processor Cores</b>	Number of cores to enable in each processor package. ▶ Options: <b>All</b> (default) and <b>1</b>
<b>Hyper-Threading</b>	<b>Enabled</b> (default) for Windows XP and Linux (OS optimized for Hyper-Threading Technology) and <b>Disabled</b> for other OS (OS not optimized or Hyper-Threading Technology). When disabled only one thread per enabled core is enabled.
<b>Intel (VMX) Virtualization Technology</b>	When enabled, a VMM can utilize the additional hardware capabilities provided by Vanderpool Technology. ▶ Options: <b>Enabled</b> (default) or <b>Disabled</b>
<b>Intel (R) Speed Step (tm)</b>	<b>Enable</b> (default)/ <b>Disable</b> Intel SpeedStep. Allows more than two frequency ranges to be supported.
<b>Turbo Mode</b>	Only available when Intel Speed Step is <b>Enabled</b> . <b>Enable /Disable</b> (default) Turbo Mode (requires EMTTM enabled, unless max turbo ratio is bigger than 16 - SKL AO W/A.

**C States**

**Enable /Disable** (default) CPU power management. Allows CPU to go to C state when it's not 100% utilized.

# BIOS

## 5.2.2. Trusted Computing



The features settings are:

Setting	Description
<b>Security Device Support</b>	<b>Enable</b> (default) or <b>Disable</b> BIOS support for security device.
<b>Pending operation</b>	Schedule an Operation for the security Device. Your computer will reboot during restart in order to change State of Security Device. ▶ Options: <b>None</b> (default) and <b>TPM Clear</b>

### 5.2.3. ACPI Settings

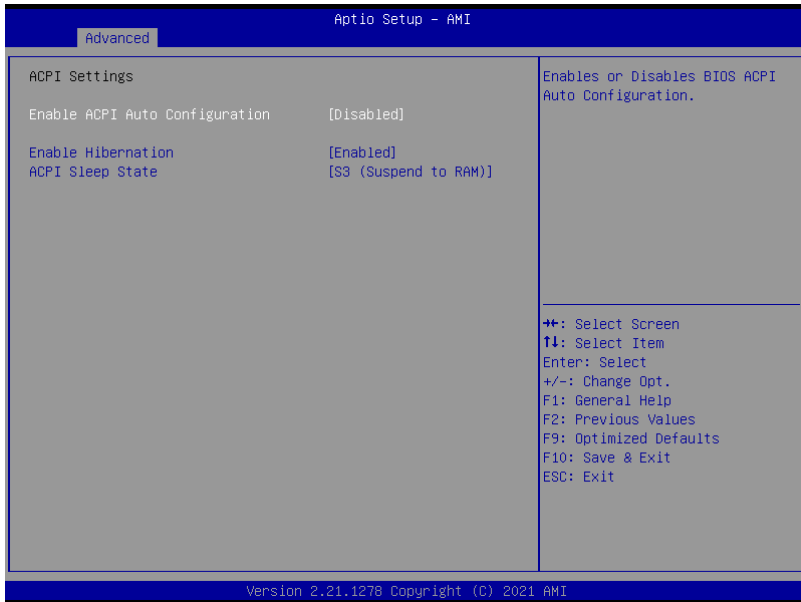

The features settings are:

Setting	Description
<b>Enable ACPI Auto Configuration</b>	<b>Enables</b> or <b>Disables</b> (default) BIOS ACPI Auto Configuration
<b>Enable Hibernation</b>	<b>Enables</b> (default) or <b>Disables</b> System ability to Hibernate (OS/S4 Sleep State). This option may be not effective with some OS.
<b>ACPI Sleep State</b>	Select ACPI sleep state the system will enter when the SUSPEND button is pressed. <b>► Options: Suspend Disabled and S3 (Suspend to RAM) (default)</b>

### 5.2.4. Super IO Configuration

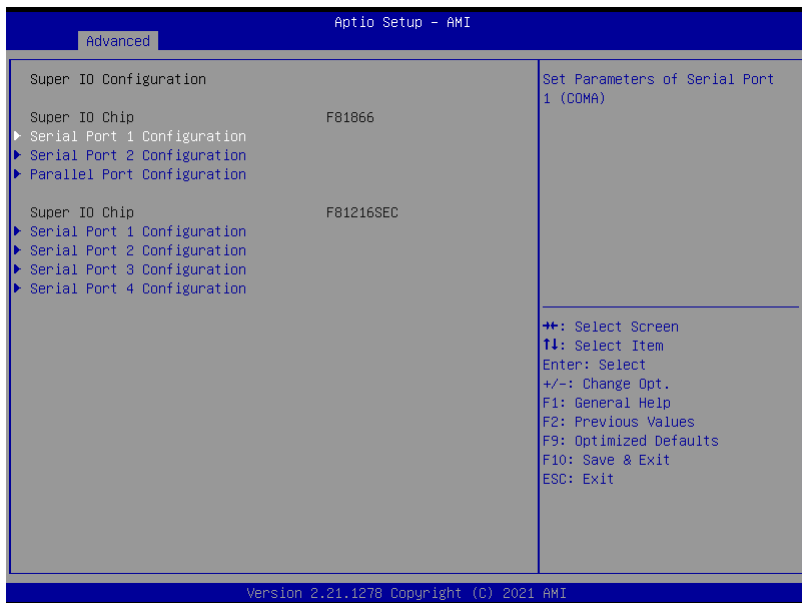

#### Super IO Chip F81866 Settings

Setting	Description
<b>Serial Port Configuration</b>	
<b>Serial Port</b>	<b>Enable</b> (default) or <b>Disable</b> Serial Port (COM).
<b>Mode Select</b>	Select <b>RS-232</b> (default), <b>RS-422</b> , <b>RS-485</b> , <b>RS-422 Termination Resistor</b> or <b>RS-485 Termination Resistor</b>
<b>Parallel Port Configuration</b>	
<b>Parallel Port</b>	<b>Enable</b> (default) or <b>Disable</b> Parallel Port (LPT/LPTE).
<b>Device Mode</b>	Change the printer port mode: ▶ Options: <b>STD Printer Mode</b> (default) ; <b>SPP Mode</b> ; <b>EPP-1.9 and SPP Mode</b> ; <b>EPP-1.7 and SPP Mode</b> ; <b>ECP Mode</b> ; <b>ECP and EPP 1.9 Mode</b> ; <b>ECP and EPP 1.7 Mode</b>

**Super IO Chip F81216SEC Settings**

Serial Port Configuration	
<b>Serial Port</b>	<b>Enable</b> (default) or <b>Disable</b> Serial Port (COM).

## 5.2.5. Hardware Monitor

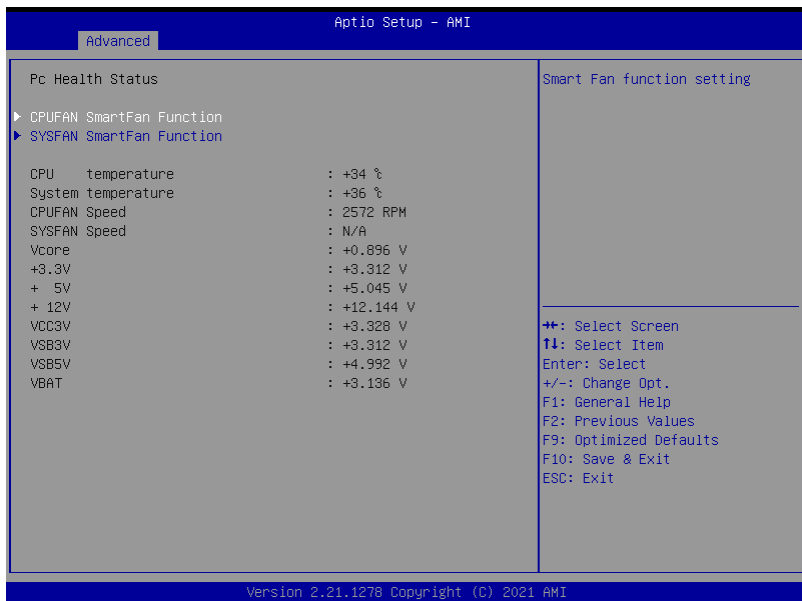

The features settings are:

Setting	Description
<b>CPUFAN SmartFan Function</b>	<b>Enables</b> (default) or <b>Disables</b> Smart Fan
<b>SYSFAN SmartFan Function</b>	<b>Boundary 1~4 &amp; Segment Speed 1~5</b> Auto fan speed control. Fan speed will follow different temperature by different PRM 1-100.

**Note:** CPUFAN & SYSFAN functions only apply to SKUs with smart fan. If your SKU doesn't come with smart fan, ignore these settings.



### 5.2.6. S5 RTC Wake Settings



The features settings are:

Setting	Description
Wake System from S5	<p><b>Enable or Disable</b> (default) system wake on alarm event.</p> <ul style="list-style-type: none"> <li>Options available are:                             <ul style="list-style-type: none"> <li><b>Disabled</b> (default):</li> <li><b>Fixed Time:</b> System will wake on the hr::min::sec specified.</li> <li><b>DynamicTime:</b> If selected, you need to set <b>Wake up minute increase</b> from 1 - 5. System will wake on the current time + increase minute(s).</li> </ul> </li> </ul>

## 5.2.7. AMI Graphic Output protocol policy

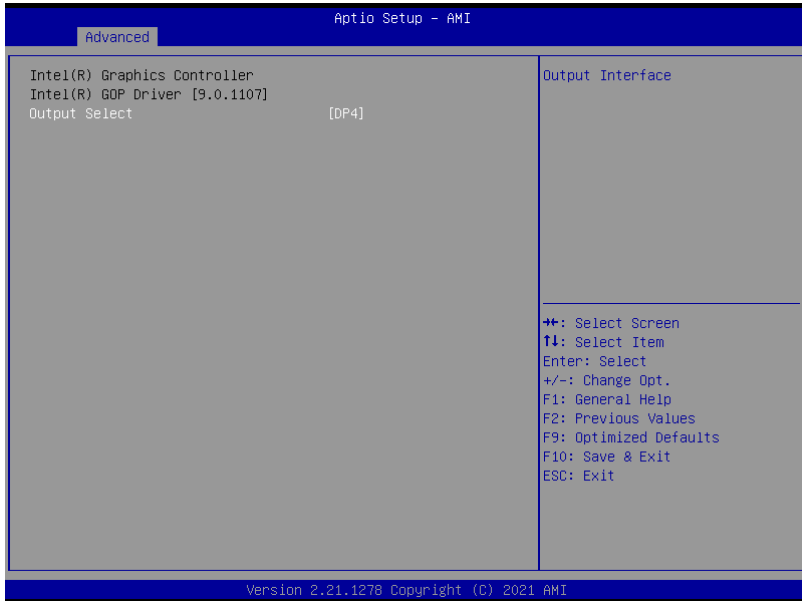

The features settings are:

Setting	Description
Output select	Output Select

### 5.2.8. PCI Sybssystem Settings

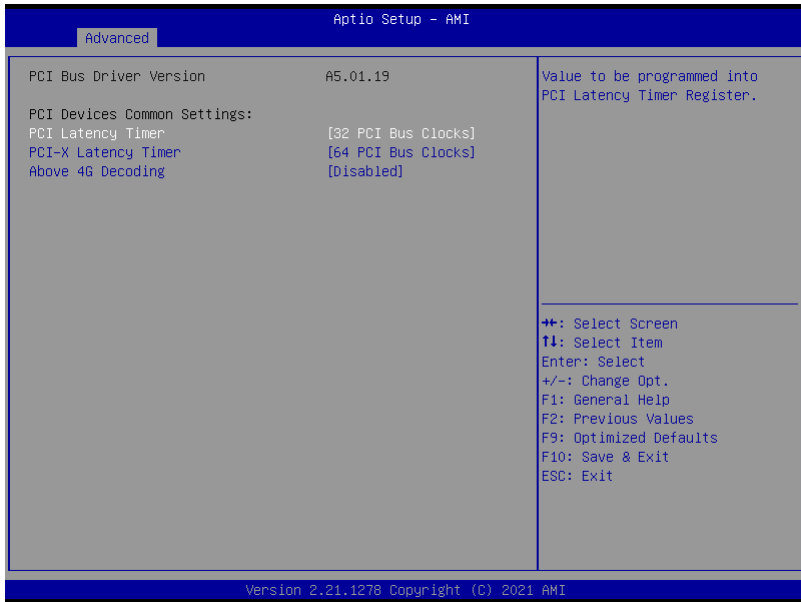

The features settings are:

Setting	Description
<b>PCI Latency Timer</b>	Value to be programmed into PCI Latency Timer Register. ▶ <b>Options: 32 (default), 64, 96, 128, 160, 192, 224 and 248 PCI Bus Clocks.</b>
<b>PCI-X Latency Timer</b>	Value to be programmed into PCI-X Latency Timer Register. ▶ <b>Options: 32, 64 (default), 96, 128, 160, 192, 224 and 248 PCI Bus Clocks.</b>
<b>Above 4G Decoding</b>	<b>Enable/Disable (default)</b> 64bit capable Devices to be Decoded in Above 4G Address Space (Only if System Supports 64 bit PCI Decoding).

### 5.2.9. USB Configuration

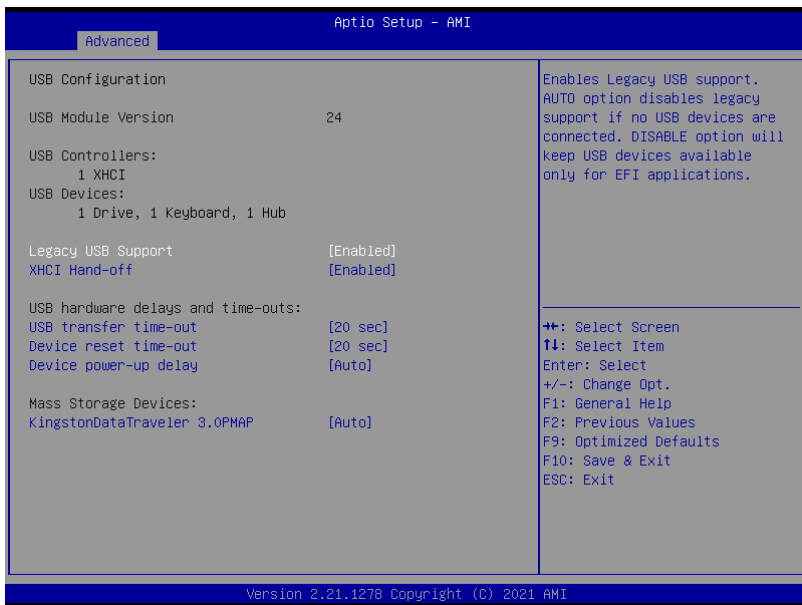

The features settings are:

Setting	Description
<b>Legacy USB Support</b>	<p>Enables/disables legacy USB support.</p> <ul style="list-style-type: none"> <li>▶ Options available are <b>Enabled</b> (default), <b>Disabled</b> and <b>Auto</b>.</li> <li>▶ Select <b>Auto</b> to disable legacy support if no USB device are connected.</li> <li>▶ Select <b>Disabled</b> to keep USB devices available only for EFI applications.</li> </ul>
<b>XHCI Hand-off</b>	<p>This is a workaround for OSeS without XHCI hand-off support. The XHCI ownership change should be claimed by XHCI driver.</p> <ul style="list-style-type: none"> <li>▶ The optional settings are: <b>Enabled</b> (default) / <b>Disabled</b>.</li> </ul>
<b>USB Transfer time-out</b>	<p>Use this item to set the time-out value for control, bulk, and interrupt transfers.</p> <ul style="list-style-type: none"> <li>▶ Options: <b>1 sec</b>, <b>5 sec</b>, <b>10 sec</b>, <b>20 sec</b> (default).</li> </ul>

<b>Device reset time-out</b>	Use this item to set USB mass storage device start unit command time-out. ▶ Options available are: <b>10 sec, 20 sec (default), 30 sec, 40 sec</b>
<b>Device power-up delay</b>	Use this item to set maximum time the device will take before it properly reports itself to the host controller. 'Auto' uses default value: for a root port it is 100 ms, for a hub port the delay is taken from hub descriptor. ▶ Options available are: <b>Auto:</b> Default <b>Manual:</b> Select <b>Manual</b> you can set value for the following sub-item: 'Device Power-up delay in seconds', the delay range in from 1 to 40 seconds, in one second increments.

5.2.10. CSM Configuration

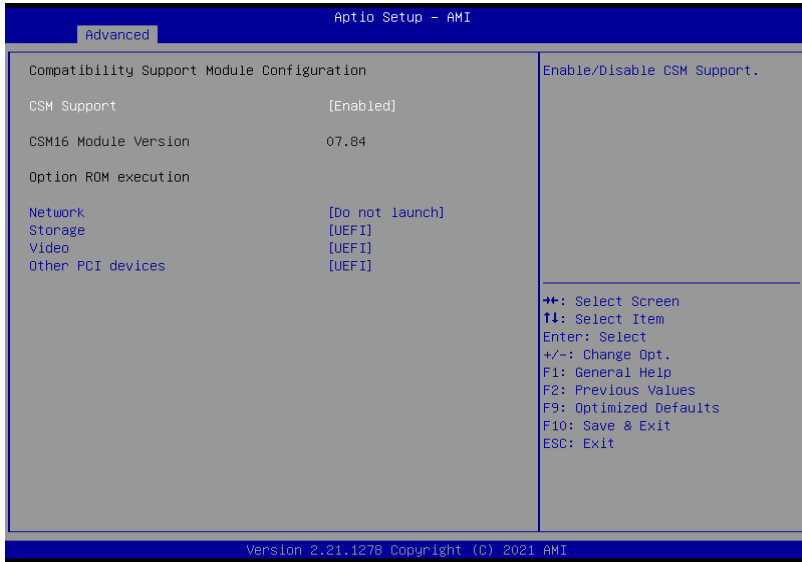

The features settings are:

Setting	Description
<b>CSM Support</b>	<b>Enable</b> (default) or <b>Disable</b> CSM Support.
<b>Network</b>	Control the execution of UEFI PXE OpROM ▶ Options: <b>Do not launch</b> (default) and <b>UEFI</b>
<b>Storage</b>	Control the execution of UEFI Storage OpROM ▶ Options: <b>Do not launch</b> and <b>UEFI</b> (default)
<b>Video</b>	Control the execution of UEFI Video OpROM ▶ Options: <b>Do not launch</b> and <b>UEFI</b> (default)
<b>Other PCI devices</b>	Determines OpROM execution policy for devices other than network, storage or video ▶ Options: <b>Do not launch</b> and <b>UEFI</b> (default)

Note: Legacy video can not be displayed in UEFI mode.

### 5.2.11. NVMe Configuration



Access this submenu to view the NVMe controller and driver information.

### 5.3. Chipset

The **Chipset** menu controls the system’s chipset.

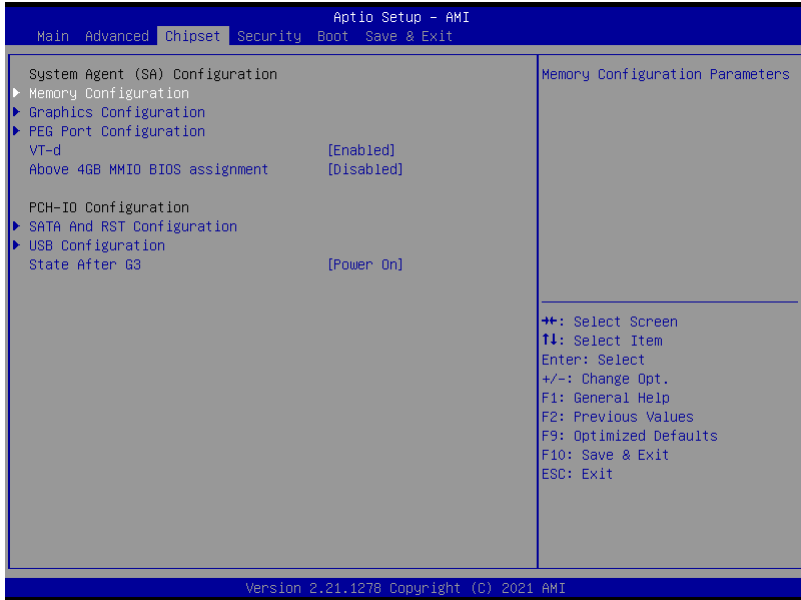

The features settings are:

Setting	Description
<b>System Agent (SA) Configuration</b>	
<b>Memory Configuration</b>	Access this submenu to view the memory configuration.
<b>Graphics Configuration</b>	See <a href="#">5.3.1.1. Graphics Configuration on page 94</a>
<b>PEG Port Configuration</b>	PEG port options <b>Enable Root Port:</b> Enable or Disable the root port. ▶ Options: <b>Auto</b> (default), <b>Enabled</b> and <b>Disabled</b> . <b>Max Link Speed:</b> Configure PEG 0:1:0 Max Speed. ▶ Options: <b>Auto</b> (default), <b>Gen1</b> , <b>Gen 2</b> and <b>Gen3</b> .
<b>VT-d</b>	<b>Enable</b> (default) or <b>Disable</b> VT-d function



<b>Above 4GB MMIO BIOS assignment</b>	<b>Enable</b> or <b>Disable</b> (default) Above 4GB MMIO BIOS assignment. This is enabled automatically when aperture size is set to 2048MB.
<b>PCH-IO Configuration</b>	
<b>SATA And RST Configuration</b>	See <a href="#">5.3.1.2. SATA And RST Configuration on page 96</a>
<b>USB Configuration</b>	See <a href="#">5.3.1.3. USB Configuration on page 97</a>
<b>State After G3</b>	Specify what state to go to when power is re-applied after a power failure (G3 state). ► Options available are <b>Power On</b> (default), <b>Power Off</b> and <b>Last State</b> .

### 5.3.1.1. Graphics Configuration

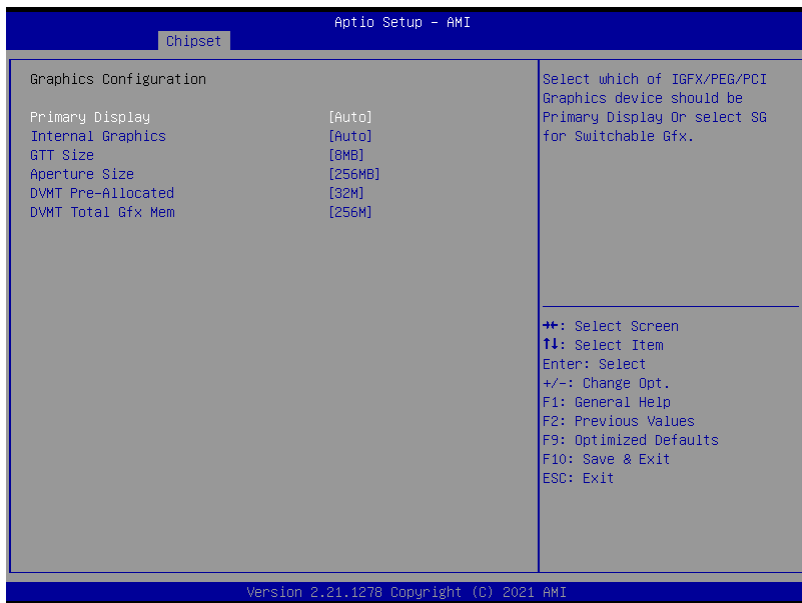

The features settings are:

Setting	Description
<b>Primary Display</b>	Select the Graphics device which will be activated as Primary Display. ▶ Options available are <b>Auto</b> (default), <b>IGFX</b> , <b>PEG</b> and <b>PCI</b>
<b>Internal Graphics</b>	Enables/disables the IGD. ▶ Options available are <b>Auto</b> (default), <b>Disabled</b> , and <b>Enabled</b> .
<b>GTT Size</b>	Select the GTT Size. ▶ Options: <b>4MB</b> , <b>2MB</b> and <b>8MB</b> (default).
<b>Aperture Size</b>	Select the Aperture Size. Note that above 4GB MMIO BIOS assignment is automatically enabled when selecting 2048MB aperture. To use this feature, please disable CSM support. ▶ Options: <b>128MB</b> , <b>256MB</b> (default), <b>512MB</b> , <b>1024MB</b> and <b>2048MB</b>

---

<b>DVMT Pre-Allocated</b>	Select the DVMT 5.0 Pre-allocated (Fixed) Graphic Memory size used by the Internal Graphic Device. ▶ 32M is the default.
<b>DVMT Total Gfx Mem</b>	Select the DVMT 5.0 Total Graphic Memory size used by the Internal Graphic Device. ▶ Options: <b>128M</b> , <b>256M</b> (default) and <b>Max</b> .

### 5.3.1.2. SATA And RST Configuration

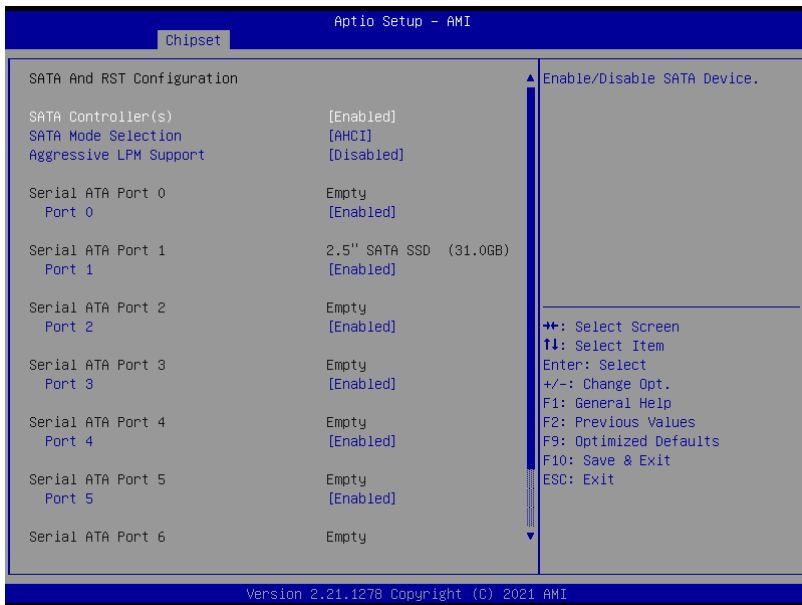

The features settings are:

Setting	Description
<b>SATA Controller(s)</b>	<b>Enables</b> (default) / <b>Disables</b> SATA device(s).
<b>SATA Mode selection</b>	Determines how SATA controller operate. <b>AHCI</b> (default) / <b>Intel RST Premium With Intel Optane System Acceleration</b>
<b>Aggressive LPM Support</b>	<b>Enables</b> / <b>Disables</b> (default) PCH to aggressively enter link power state.
<b>Serial ATA Port 0~6</b>	SATA device information. <b>Enables</b> (default) / <b>Disables</b> the SATA port. *Available SATA ports depend on your model.

### 5.3.1.3. USB Configuration



The features settings are:

Setting	Description
<b>XHCI Disable Compliance Mode</b>	Options to disable Compliance Mode. Default is <b>FALSE</b> (default) to not disable Compliance Mode. Set <b>TRUE</b> to disable Compliance Mode.
<b>xDCI Support</b>	<b>Enable / Disable</b> (default) xDCI (USB OTG Device).

## 5.4. Security

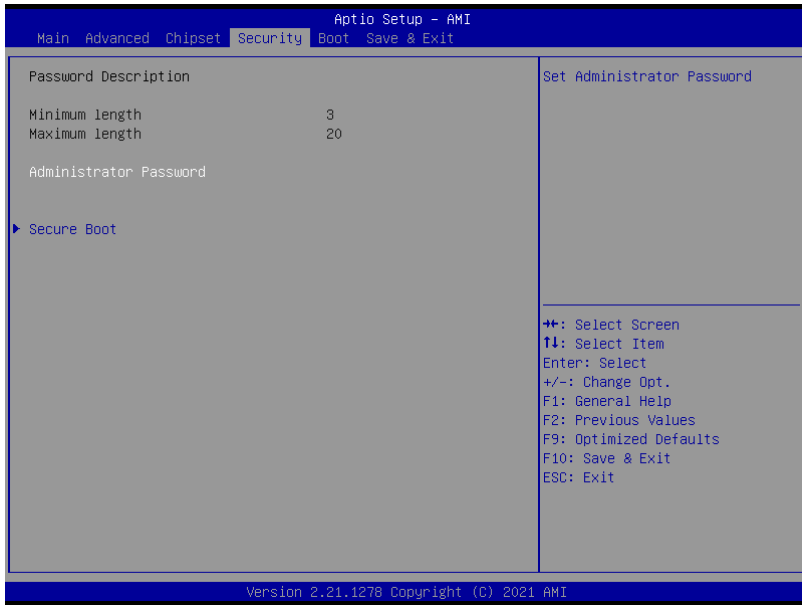

The features settings are:

Setting	Description
<b>Administrator Password</b>	To set up an administrator password: <ol style="list-style-type: none"> <li>1. Select <b>Administrator Password</b>.</li> <li>2. An <b>Create New Password</b> dialog then pops up onscreen.</li> <li>3. Enter your desired password that is no less than 3 characters and no more than 20 characters.</li> <li>4. Hit [Enter] key to submit.</li> </ol>
<b>Security Boot</b>	See <a href="#">5.4.1. Security Boot on page 99</a> .

### 5.4.1. Security Boot



The features settings are:

Setting	Description
<b>Secure Boot</b>	<b>Enable/Disable</b> (default) secure boot.
<b>Secure Boot Mode</b>	Allow users to set the secure boot selector. <b>Standard/Custom</b> (default) mode.
<b>Restore Factory Keys</b>	Force system to restore default secure boot key database.
<b>Reset to Setup Mode</b>	Delete all secure boot key databases.
<b>Key Management</b>	Allow users to modify secure variables and set key management page.

## 5.5. Boot

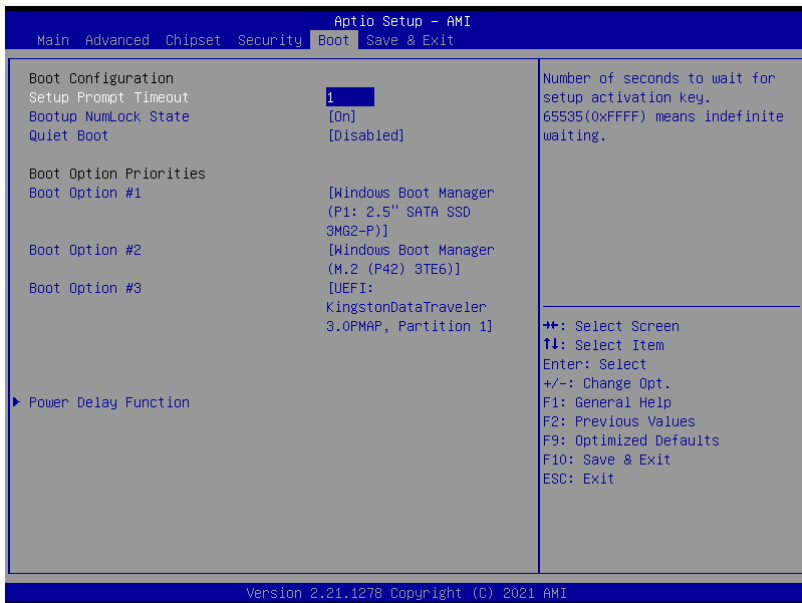

The features settings are:

Setting	Description
<b>Setup Prompt Timeout</b>	Set how long to wait for the prompt to show for entering BIOS Setup. <ul style="list-style-type: none"> <li>▶ The default setting is <b>1</b> (sec).</li> <li>▶ Set it to <b>65535</b> to wait indefinitely.</li> </ul>
<b>Bootup NumLock State</b>	Sets whether to enable or disable the keyboard's NumLock state when the system starts up. <ul style="list-style-type: none"> <li>▶ Options available are <b>On</b> (default) and <b>Off</b>.</li> </ul>
<b>Quiet Boot</b>	Sets whether to display the POST (Power-on Self Tests) messages or the system manufacturer's full screen logo during booting. <ul style="list-style-type: none"> <li>▶ Select <b>Disabled</b> to display the normal POST message, which is the default.</li> </ul>
<b>Boot Option Priority</b>	Set the system boot priorities.



<b>Hard Drive BBS Priorities</b>	Sets the order of the legacy devices in this group. BBS means "BIOS Boot Specification".
<b>Power Delay Function</b>	<p><b>Power Delay Function</b> Set the system support power delay function.</p> <ul style="list-style-type: none"><li>▶ Options: <b>Enable</b> (default): Support power delay function. <b>Disable</b>: Power on/off manually operated.</li></ul> <p><b>Power on delay</b> Select the time which the system will power on.</p> <ul style="list-style-type: none"><li>▶ Options: <b>Manually Operator</b> (default), <b>04 Seconds</b>, <b>08 Seconds</b> and <b>16 Seconds</b>.</li></ul> <p><b>Power off delay</b> Select the time which the system will shutdown.</p> <ul style="list-style-type: none"><li>▶ Options: <b>Manually Operator</b> (default), <b>30 Seconds</b>, <b>60 Seconds</b> and <b>90 Seconds</b>.</li></ul>

## 5.6. Save & Exit

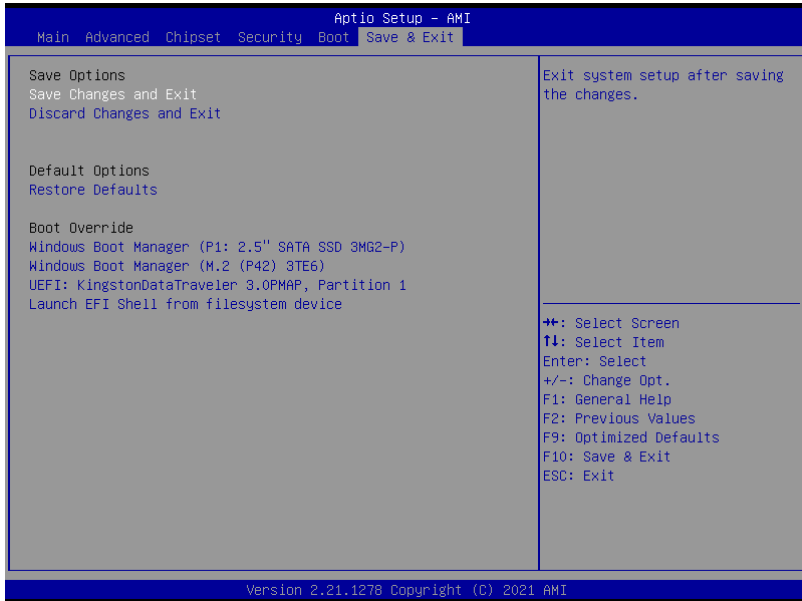

The features settings are:

Setting	Description
<b>Save Changes and Reset</b>	Saves the changes and quits the BIOS Setup utility.
<b>Discard Changes and Exit</b>	Quits the BIOS Setup utility without saving the change(s).
<b>Restore Defaults</b>	Restores all settings to defaults. ▶ This is a command to launch an action from the BIOS Setup utility.
<b>Boot Override</b>	<b>Boot Override</b> presents a list in context with the boot devices in the system. ▶ <b>P0:</b> Select the device to boot up the system regardless of the currently configured boot priority. ▶ <b>Launch EFI Shell from filesystem device:</b> Attempts to launch EFI Shell Application (Shell.efi) from one of the available filesystem devices.



# Appendices

### A: Digital I/O Setting

Digital I/O can read from or write to a line or an entire digital port, which is a collection of lines. This mechanism helps users achieve various applications such as industrial automation, customized circuit, and laboratory testing. Take the source code below that is written in C for the digital I/O application example.

#### Sample Codes:

```
/*-----*/
-----*/
#include <math.h>
#include <stdio.h>
#include <dos.h>

int sioIndex = 0x2E;
int sioData = 0x2F;

int main(void)
{
    int iData;

    SioGPIOMode(0xFF00);
    delay(2000);

    SioGPIOData(0x5500);
    delay(2000);

    iData = SioGPIOStatus();
    printf(" Input : %2x \n",iData);
    delay(2000);

    SioGPIOData(0xAA00);
    delay(2000);

    iData = SioGPIOStatus();
    printf(" Input : %2x \n",iData);
    delay(2000);

    return 0;
}

void SioGPIOMode(int iMode)
{
    int iTemp;

    outportb(sioIndex,0x87); /* Enable
Super I/O */
    outportb(sioIndex,0x87);

    outportb(sioIndex,0x07); /* Select
```

```

logic device - GPIO */
    outportb(sioData, 0x06);

    outportb(sioIndex,0x30); /* Enable
GPIO */
    outportb(sioData, 0x01);

    iTemp = iMode & 0x00FF;
    outportb(sioIndex,0xA0); /* GPIO
50~57 - Output Enable */
    outportb(sioData,iTemp);

    iTemp = (iMode & 0xFF00) >> 8;
    outportb(sioIndex,0xF0); /* GPIO
00~07 - Output Enable */
    outportb(sioData,iTemp);

    outportb(sioIndex,0xAA); /* Disable
Super I/O */
}

void SioGPIOData(int iData)
{
    int iTemp;

    outportb(sioIndex,0x87); /* Enable
Super I/O */
    outportb(sioIndex,0x87);

    outportb(sioIndex,0x07); /* Select
logic device - GPIO */
    outportb(sioData, 0x06);

    iTemp = iData & 0x00FF;
    outportb(sioIndex,0xA1); /* GPIO
50~57 - Output Data */
    outportb(sioData,iTemp);

    iTemp = (iData & 0xFF00) >> 8;
    outportb(sioIndex,0xF1); /* GPIO
00~07 - Output Data */
    outportb(sioData,iTemp);

    outportb(sioIndex,0xAA); /* Disable
Super I/O */
}

int SioGPIOStatus()
{
    int iStatus;
    int iTemp;

```

## Appendices

---

```
        outportb(sioIndex,0x87);                /* Enable
Super I/O */
        outportb(sioIndex,0x87);

        outportb(sioIndex,0x07);                /* Select
logic device - GPIO */
        outportb(sioData, 0x06);

        outportb(sioIndex,0xA2);                /* GPIO
50~57 - Status */
        iTemp = inportb(sioData);

        outportb(sioIndex,0xF2);                /* GPIO
00~07 - Status */
        iStatus = inportb(sioData);

        outportb(sioIndex,0xAA);                /* Disable
Super I/O */

        iStatus = (iStatus<<8) + iTemp;

        return iStatus;
}
```

## B: Watchdog Timer (WDT) Setting

WDT is widely used for industry application to monitor the activity of CPU. Application software depends on its requirement to trigger WDT with adequate timer setting. Before WDT time out, the functional normal system will reload the WDT. The WDT never time out for a normal system. The WDT will not be reloaded by an abnormal system, then WDT will time out and auto-reset the system to avoid abnormal operation.

This computer supports 255 levels watchdog timer by software programming I/O ports.

Below is an assembly program example to disable and load WDT.

### Sample Codes:

```

/*-----
----*/
#include <math.h>
#include <stdio.h>
#include <dos.h>

int sioIndex = 0x4E;          /* or 0x2E */
int sioData = 0x4F;         /* or 0x2F */

int main(void)
{
    int    iCount;
    printf("WDT Times ( 1 ~ 255 ) : \0");
    scanf("%d",&iCount);
    printf("\n");

    SioWDTStart(iCount);

    while(1)
    {
        iCount = SioWDTCount();
        printf("\r Counts : %d ",iCount);
        sleep(1);
    }

    return 0;
}

void SioWDTStart(int iCount)
{
    outportb(sioIndex, 0x87);          /* Enable
Super I/O */

```

---

## Appendices

---

```
        outportb(sioIndex, 0x87);

        outportb(sioIndex, 0x07); /* Select
logic device - WDT */
        outportb(sioData, 0x07);

        outportb(sioIndex, 0x30); /* Enable
WDT */
        outportb(sioData, 0x01);

        outportb(sioIndex, 0xFA); /* Enable
WDRST# Output */
        outportb(sioData, 0x01);

        outportb(sioIndex, 0xF6); /* Set WDT
Timeout value */
        outportb(sioData, iCount);

        outportb(sioIndex, 0xF5); /* Set
Configure and Enable WDT timer, Start countdown */
        outportb(sioData, 0x32);

        outportb(sioIndex, 0xAA); /* Disable
Super I/O */
    }

void SioWDTStop(void)
{
    outportb(sioIndex, 0x87); /* Enable
Super I/O */
    outportb(sioIndex, 0x87);

    outportb(sioIndex, 0x07); /* Select
logic device - WDT */
    outportb(sioData, 0x07);

    outportb(sioIndex, 0xF5); /* Disable
WDT timer, stop countdown */
    outportb(sioData, 0x12);

    outportb(sioIndex, 0xAA); /* Disable
Super I/O */
}

void SioWDTClear(int iCount)
{
    outportb(sioIndex, 0x87); /* Enable
Super I/O */
    outportb(sioIndex, 0x87);

    outportb(sioIndex, 0x07); /* Select
```



```
logic device - WDT */
    outportb(sioData, 0x07);

        outportb(sioIndex, 0xF6);                /* Reset WDT
Timeout Value */
        outportb(sioData, iCount);

        outportb(sioIndex, 0xAA);                /* Disable
Super I/O */
    }

int SioWDTCount(void)
{
    int iData;

        outportb(sioIndex, 0x87);                /* Enable
Super I/O */
        outportb(sioIndex, 0x87);

        outportb(sioIndex, 0x07);                /* Select
logic device - WDT */
        outportb(sioData, 0x07);

        outportb(sioIndex, 0xF6);                /* Get count
of timer */
        iData = inportb(sioData);

        outportb(sioIndex, 0xAA);                /* Disable
Super I/O */

    return iData;
}
```